



CDI-E039

Canon

PowerShot A200

PowerShot A100

DIGITAL CAMERA

Camera User Guide

This guide covers both the PowerShot A200 and PowerShot A100 digital cameras.

Canon

- Please read the "Read this First" section (p.11).
- Please refer to the "Software Starter Guide" for information on installing the software and downloading images.
- Please read the "Quick Start" section on the following page for a simple explanation of shooting, replaying and erasing.
- Please also read the "Printer User Guide" included with your Canon printer.

Exif Print

DPOF

DIRECT
PRINT

Quick Start

- 1** **Install the batteries and CF card** (p. 19)
- Open the CF card slot / battery cover and insert a CF card and batteries.

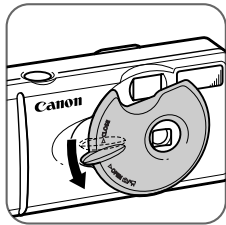
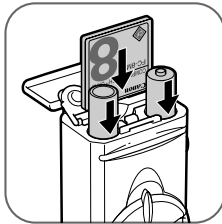

- 2** **Open the lens cover to turn the power on** (p. 27)
- The green indicator next to the optical viewfinder starts flashing green.

- When the date / time set up menu are displayed, refer to page 24.
- For information about how to change the language, see “Setting the Language” (p. 25).

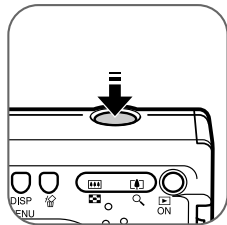

- 3** **Set the focus** (p. 34)
- Aim the camera at the subject, and lightly press the shutter button half way. The camera beeps twice when it is focused.

- 4** **Shoot the image** (p. 34)
- Press the shutter button all the way down. The camera beeps once when the image is shot.



- 5** **View the image**
- The recorded image will be displayed for approximately 3 seconds (p. 35). Refer to [Replaying] section (p. 59) for viewing other images already shot.

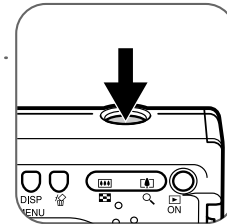

To erase

- 1** Press the  button while the image is displayed.
- 2** Confirm that [Erase] is selected and press the SET button.



When you have finished shooting photos

① Installing the software	⇒ Software Starter Guide
② Connecting the camera to a computer	⇒ This guide
③ Downloading images to a computer	⇒ Software Starter Guide

Front View

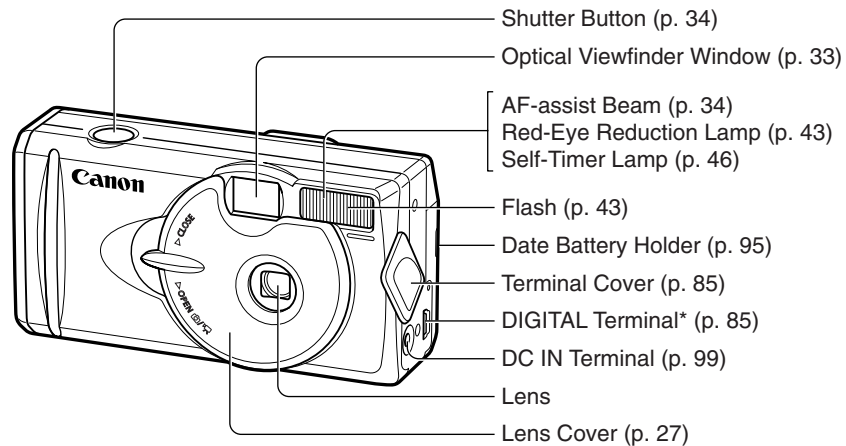

* For connecting your camera to a computer via a USB Interface Cable IFC-300PCU (supplied with camera) (p.85) or connecting to a Direct Print Function compliant printer via Direct Interface Cable DIF-100 (supplied with printer) (p. 69).
(For a list of printers that work with this camera, please refer to the System Map.)

Back View

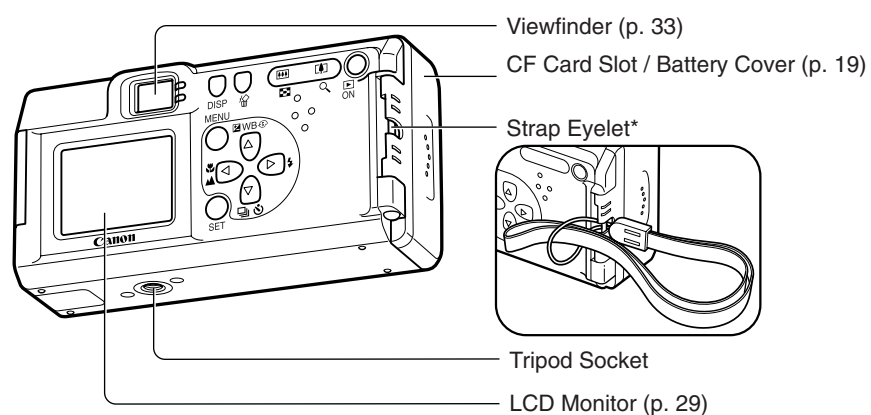

* Be careful when carrying the camera by the strap. Don't swing the camera on the strap, and keep the strap and camera body clear of obstacles.

Operation Panel

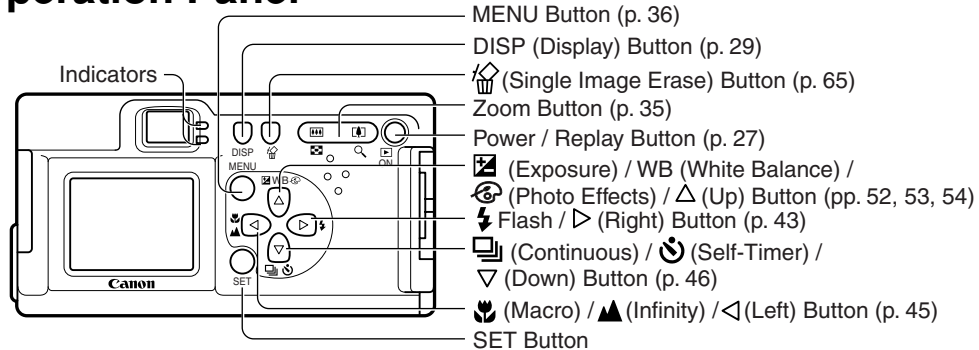

Indicators

The upper indicator comes on when you open the lens cover or whenever you press the shutter button.

Upper Indicator

- Green: Ready to shoot, or ready to communicate with your computer.
- Flashing Green: Camera is starting up, reading the CF card, erasing data on the CF card, or transmitting data to your computer.
- Orange: Ready to shoot, using the flash.

Flashing Orange: Ready to shoot, (camera shake warning) / charging the flash (at LCD ON).

Lower Indicator

- Yellow: Macro / Infinity modes
- Flashing Yellow: Focusing difficulty (Although you can press the shutter button, it is recommended to use the focus lock to shoot (p. 50)).

About this Camera User Guide

Symbols Used

Icons on the right end of title bars show the operations mode. As in the example below, the shooting mode should be set to , , or .

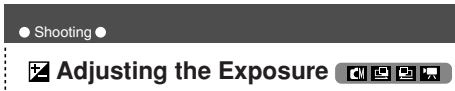

This mark denotes issues that may affect the camera's operation.

This mark denotes additional topics that complement the basic operating procedures.

Question? Look here first.

- How do I navigate the menus? Selecting Menus and Settings (p. 36)
- What settings are available under each function? and
● Will my settings remain in effect even after I've turned the camera off? Functions Available in Each Shooting Mode (p. 57)
- How do I go about printing? About Printing (p. 67)
- What functions are available through the menus? Rec. Menu (p. 87)
Play Menu (p. 89)
Set up Menu (p. 90)

■ : Functions and operations tables.

Quick Start	2
Components Guide	4
Front View	4
Back View	5
Operation Panel	6
About this Camera User Guide	7
Read this First	11
Preparing the Camera	19
Installing the Battery and CF Card	19
Setting the Date / Time	24
Setting the Language	25
Basic Functions	27
Turning the Power ON / OFF	27

Using the LCD Monitor	29
Information Displayed on the LCD Monitor	31
Using the Viewfinder	33
Pressing the Shutter Button	34
Using the Digital Zoom	35
Selecting Menus and Settings	36
Menu Settings and Default Settings	38
Shooting	40
Selecting the Shooting Mode	40
Changing the Resolution / Compression ..	41
⚡ Using the Flash	43
🌸 Macro / ▲ Infinity Modes	45
📄 Continuous Mode	46
🕒 Self-Timer	46
Stitch Assist Mode	47

Movie Mode	49
Using the Focus Lock	50
Switching Between Autofocus Modes	51
📷 Adjusting the Exposure	52
WB Setting the White Balance	53
🔄 Switching Between Photo Effect Modes ..	54
Changing the ISO Speed	55
Resetting the File Number	56
Functions Available in Each Shooting Mode	57

Replaying	59
Displaying Images Individually	59
Viewing Images in Sets of 9	60
Viewing Movies	61
Rotating Images in the Display	62
Auto Play	63
Protecting Images	64
Erasing	65
Erasing Images Individually	65

Erasing All Images	65
Formatting a CF Card	66

Printing	67
About Printing	67
Selecting from the Print Order Menu	68
Connecting the Camera to a Printer	69
Printing	71
Print Settings (Direct Print Function)	72
DPOF Print Settings	76
Printing with DPOF Print Settings	80

Image Transfer Settings (DPOF Transfer Order)	82
Setting the Image Transfer	82

Downloading Images to a Computer	84
Downloading Directly from a CF Card	84
Connecting the Camera to a Computer Via the USB Cable	85

List of Menu Options and Messages 87

Rec. Menu 87

Play Menu 89

Set up Menu 90

Resetting the Settings to Default 91

List of Messages 92

Appendices 95

Replacing the Date Battery 95

Using the Optional Battery Kits 96

Camera Care and Maintenance 100

Troubleshooting 101

Specifications 106

Index 113

Read this First

Accessories

This digital camera is designed to perform optimally when used with genuine Canon brand digital camera accessories (“Canon Brand Accessories”).

You may use non Canon Brand Accessories with this Digital camera. However, Canon Makes no warranties concerning, and is not responsible for damages resulting from, use of non Canon Brand Accessories.

Camera Body Temperature

If your camera is used for prolonged periods, the camera body may become warm. Please be aware of this and take care when operating the camera for an extended period.

About the LCD Monitor

The LCD monitor is produced with extremely high-precision manufacturing techniques. More than 99.99% of the pixels operate to specification. Less than 0.01% of the pixels may occasionally misfire or appear as red or black dots. This has no effect on the recorded image and does not constitute a malfunction.

Language Setting

Please see page 25 to change the language setting.

Please Read

Test Shots

Before you shoot images of subjects of importance to you, we strongly recommend that you shoot several trial images to confirm that you are operating the camera correctly.

Please note that Canon, its subsidiaries and affiliates, and distributors of its digital cameras are not liable for any consequential damages arising from any malfunction of the Canon digital camera or CompactFlash™ card (CF card) resulting in the failure of an image to be recorded or to be recorded in a format that is machine readable.

Warning Against Copyright Infringement

Please note that Canon digital cameras are intended for personal use and must be used in a manner that respects international and domestic copyright laws and regulations.

Please be advised that in certain cases the copying of images from performances, exhibitions, or commercial properties by means of a camera or other device may contravene copyright or other legal rights even if the image was recorded for personal use.

Warranty Limitations

This camera's warranty is only effective in the country of sale. If a problem arises while the camera is in use abroad, please convey it back to the country of sale before proceeding with a warranty claim to a Canon Customer Support Help Desk.

For Canon Customer Support contacts, please see the Canon Limited Warranty supplied with your camera.

Safety Precautions

- Before using the camera, please ensure that you have read and understood the safety precautions described below. Always ensure that the camera is operated correctly.
- The safety precautions noted on the following pages are intended to instruct you in the safe and correct operation of the camera and its accessories to prevent injuries or damage to yourself, other persons and equipment.
- In the next few pages, the term “equipment” refers primarily to the camera, battery, battery charger and optional compact power adapter.

⚠ WARNINGS

- Do not aim the camera directly into the sun or at other intense light sources which could damage your eyesight.
- Do not trigger the flash in close proximity to human or animal eyes. Exposure to the intense light produced by the flash may damage eyesight. In particular, remain at least one meter (39 inches) away from infants when using the flash.
- Store this equipment out of the reach of children and infants. Accidental damage to the camera or batteries by a child could result in serious injury. In addition, placement of the strap around the child's neck could result in asphyxiation.
- Be particularly careful to keep the date battery used in the camera away from children. Seek medical assistance immediately if a child swallows a battery.
- Do not attempt to disassemble or alter any part of the equipment that is not expressly described in this guide. Disassembly or alteration may result in high-voltage electrical shock. Internal inspections, alterations and repairs should be conducted by qualified service personnel authorized by your camera distributor or a Canon Customer Support Help Desk.
- To avoid the risk of high-voltage electrical shock, do not touch the flash portion of the camera if it has been damaged. Similarly, never touch internal portions of the equipment that become exposed as a result of damage. There is a risk of high-voltage electrical shock. Please take the first opportunity to consult your camera distributor or a Canon Customer Support Help Desk.
- Stop operating the equipment immediately if it emits smoke or noxious fumes. Failure to do so may result in fire or electrical shock. Immediately turn the camera's power off, remove the camera batteries and unplug the power cord from the electrical outlet. Confirm that smoke or fume emissions have ceased. Please consult your camera distributor or the closest Canon Customer Support Help Desk.

- Stop operating the equipment if it is dropped or the casing is damaged. Failure to do so may result in fire or electrical shock. Immediately turn the camera's power off, remove the camera batteries and unplug the power cord from the electrical outlet. Please consult your camera distributor or the closest Canon Customer Support Help Desk.
- Do not allow the equipment to come into contact with, or become immersed in, water or other liquids. Do not allow liquids to enter the interior. The camera has not been waterproofed. If the exterior comes into contact with liquids or salt air, wipe it dry with a soft, absorbent cloth. In the event that water or other foreign substances enter the interior, immediately turn the camera's power off and remove the camera batteries or unplug the power cord from the electrical outlet. Continued use of the equipment may result in fire or electrical shock. Please consult your camera distributor or the closest Canon Customer Support Help Desk.
- Do not use substances containing alcohol, benzene, thinners or other flammable substances to clean or maintain the equipment. The use of these substances may lead to fire.
- Remove the power cord on a regular periodic basis and wipe away the dust and dirt that collects on the plug, the exterior of the electrical outlet and the surrounding area. In dusty, humid or greasy environments, the dust that collects around the plug over long periods of time may become saturated with humidity and short-circuit, leading to fire.
- Do not cut, damage, alter or place heavy items on the power adapter cord. Any of these actions may cause an electrical short circuit, which may lead to fire or electrical shock.
- Do not handle the power cord if your hands are wet. Handling it with wet hands may lead to electrical shock. When unplugging the cord, ensure that you hold the solid portion of the plug. Pulling on the flexible portion of the cord may damage or expose the wire and insulation, creating the potential for fires or electrical shocks.
- Use of power sources not expressly recommended for this equipment may lead to overheating, distortion of the equipment, fire, electrical shock or other hazards. Use only the recommended power accessories.

- Do not place the batteries near a heat source or expose them to direct flame or heat. Neither should you immerse them in water. Such exposure may damage the batteries and lead to the leakage of corrosive liquids, fire, electrical shock, explosion or serious injury.
- Do not attempt to disassemble, alter or apply heat to the batteries. There is serious risk of injury due to an explosion. Immediately flush with water any area of the body, including the eyes and mouth, skin or clothing, that comes into contact with the inner contents of a battery.
- Avoid dropping or subjecting the batteries to severe impacts that could damage the casings. It could lead to leakage and injury.
- Do not short-circuit the battery terminals with metallic objects, such as key holders. It could lead to overheating, burns and other injuries.
- Before you discard a battery, cover the terminals with tape or other insulators to prevent direct contact with other objects. Contact with the metallic components of other materials in waste containers may lead to fire or explosions. Discard the batteries in specialized waste facilities if available in your area.
- Use of batteries not expressly recommended for this equipment may cause explosions or leaks, resulting in fire, injury and damage to the surroundings. Use only recommended batteries and accessories.
- If using AA-size NiMH batteries, use only Canon AA-size NiMH batteries and the charger recommended for use with these batteries. Use of another charger may cause batteries to overheat or deform, posing risk of fire or electric shock.
- Disconnect the battery charger or compact power adapter from both the camera and electrical outlet after recharging and when the camera is not in use to avoid fires and other hazards.
- The camera terminal of the battery charger cord and the compact power cord is designed for exclusive use with your camera. Do not use it with other products or batteries. There is a risk of fire and other hazards.

⚠ CAUTIONS

- Avoid using, placing or storing the equipment in places subject to strong sunlight or high temperatures, such as the dashboard or trunk (boot) of a car. Exposure to intense sunlight and heat may cause the batteries to leak, overheat or explode, resulting in fire, burns or other injuries. High temperatures may also cause deformation of the casing. Ensure that there is good ventilation when using the compact power adapter to charge the battery pack or power the camera.
- Do not store the equipment in humid or dusty areas. Storage in such areas could lead to fire, electrical shock or other damage.
- Be careful not to bang the camera or subject it to strong impacts or shocks that could lead to injury or damage the equipment when wearing or holding it by the strap.
- Be careful not to cover the flash with your fingers when shooting. In addition, do not touch the surface of the flash after taking several pictures in rapid succession. Either action could result in burns.
- If your camera is used for prolonged periods, the camera body may become warm. Please take care when operating the camera for an extended period as your hands may experience a burning sensation.

Preventing Malfunctions

● Avoid Strong Magnetic Fields

Never place the camera in close proximity to electric motors or other equipment generating strong electromagnetic fields.

Exposure to strong magnetic fields may cause malfunctions or corrupt image data.

● Avoid Condensation Related Problems

Moving the equipment rapidly between hot and cold temperatures may cause condensation (water droplets) to form on its external and internal surfaces. You can avoid this by placing the equipment in an airtight, resealable plastic bag and letting it adjust to temperature changes slowly before removing it from the bag.

● If Condensation Forms Inside the Camera

Stop using the camera immediately if you detect condensation.

Continued use may damage the equipment. Remove the CF card and battery or power cord (if connected) from the camera and wait until the moisture evaporates completely before resuming use.

● Extended Storage

When not using the camera for extended periods of time, remove the batteries from the camera or battery charger and store the equipment in a safe place. Storing the camera for extended periods with batteries installed will run down the battery and may damage the camera.

Preparing the Camera

Installing the Battery and CF Card

Insert two (2) AA-size alkaline batteries (included with the camera) or two (2) NiMH batteries (sold separately) and insert the CF card.

- 1 Be sure that the camera power is off.
- 2 Slide the CF card slot / battery cover and open the battery cover.

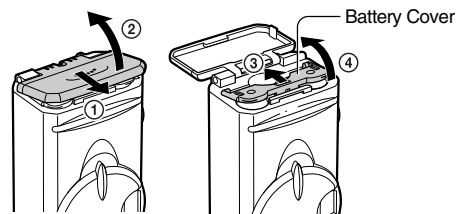

- 3 Insert the batteries as shown and close the battery cover.

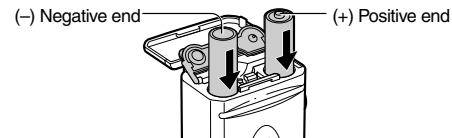

- 4 Insert the CF card as shown. Slide the CF card firmly to the end. To release the CF card, hold onto it and remove.

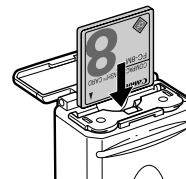

5 Close the CF card slot / battery cover.

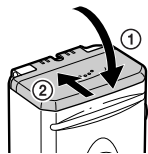

- When the camera's indicator flashes green, do not turn off the power or open the battery cover. The camera is writing, reading, erasing or transmitting an image to or from the CF card. Do not perform the following operations as recorded images may be damaged as a result.
 - Turn the camera off
 - Open the cover
 - Shake the camera
- Be aware that use of CF cards whose contents have been edited on another camera or with another company's software may cause the camera to operate incorrectly.



- We recommend that you use the optional AC Adapter Kit ACK800 to power the camera during long usage sessions (p. 99).
- The optional battery charger kit lets you use rechargeable NiMH batteries to power the camera (p. 96).
- For information about the Battery and Charger Kit and AA-size rechargeable NiMH batteries, see the System Map (separate from this guide).
- For important information, see "Battery Performance" (p. 109) and "CF Cards and Estimated Capacities (Recordable Images)" (p. 110).

Proper Battery Handling

- Use AA-size Alkaline or Canon AA-size NiMH batteries only. Refer to "Using Rechargeable Batteries" (p. 96) for their handling.
- Never use manganese or lithium batteries, as these battery types may overheat in the camera.
- Since the performance of alkaline batteries may differ according to brand, the operating time of the batteries you purchase may not be as long as the batteries that came with the camera.
- Camera operating time may shorten at low temperatures when alkaline batteries are used. Also due to their specifications, alkaline batteries may expire faster than NiMH batteries. If you are using the camera in cold areas or for a long time, we recommend using Canon AA-size NiMH Battery Kit.
- While it is possible to use AA-size nickel-cadmium batteries, performance is unreliable and their use is not recommended.

- Never mix unused and partially used batteries. Always load two fresh (or fully recharged) batteries at the same time.
- Never mix batteries of different types or from different manufactures. Both batteries should be identical.
- Before inserting the batteries, wipe the battery terminals well with a dry cloth. Oil from one's skin or other dirt may cause a considerable reduction in the number of recordable images or reduced usage time.
- Before using the camera, wipe the ⊕ and ⊖ terminals in the camera well with a dry cloth. Dirt may cause a bad electrical contact.
- Battery performance deteriorates at low temperatures (especially with alkaline batteries). If you are using the camera in cold areas and batteries are running down faster than they should, you may be able to restore performance by placing batteries in an inner pocket to warm them up prior to use. But be careful that you don't put the batteries into a pocket together with a metal key chain or other metallic objects, as these objects may cause batteries to short-circuit.

- If you do not plan to use the camera for a long time, remove the batteries from the camera and store them in a safe place. Batteries may leak and damage the camera if left installed during prolonged periods of non-use.

⚠ WARNING

Never use damaged batteries or batteries whose outer seal is completely or partially missing or peeled off, as there is risk that such batteries may leak, overheat, or burst. Always check the seals on store-bought batteries before loading them, as some batteries may come with defective seals. Do not use batteries with defective seals.

Never use batteries that look like this.



Batteries with all or part of the seal (electrical insulation sheath) peeled off.



The positive electrode (plus terminal) is flat.



The negative terminal is correctly formed (protruding from the metal base), but the seal does not extend up over the edge of the metal base.

Battery Status Indications

The LCD monitor displays an icon or message to let you know when batteries are low or depleted.



Batteries are beginning to run low. Replace (or recharge) batteries promptly. If the LCD monitor is off, this icon will appear when you press any of the following buttons: / / / / SET, DISP or / WB / .

Change the batteries

Batteries are fully depleted and the camera can no longer operate. Replace the batteries immediately.

About CF Cards

- CF cards are high-precision electronic devices. Do not bend them, apply force to them, or subject them to shocks or vibration.
- Do not attempt to disassemble or alter a CF card.
- Moving a CF card rapidly between temperature extremes will cause condensation to form in the card and lead to a malfunction. To avoid condensation, place the CF card in a sealed plastic bag before moving it into a different temperature zone and allow it to adjust slowly to the new temperature. If condensation forms on the CF card, store it at room temperature until the water droplets have evaporated naturally.
- Do not use or store CF cards in the following types of location.
 - Locations subject to dust or sand
 - Locations subject to high humidity and high temperatures

Setting the Date / Time

The Date / Time menu will be displayed when camera power is turned on for the first time or at low date battery power. Perform operations from Step 5. (Replace the date battery when power from the current one is exhausted (p. 95).)

- 1 Turn the power on (p. 27).
- 2 Press the **MENU** button.
The Rec. or Replay menu will display.

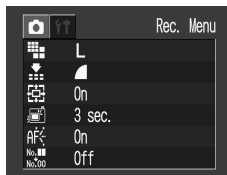

- 3 Press \leftarrow or \rightarrow button to select the **[SET] (Set up)]** menu.



- 4 Press \uparrow or \downarrow button to select **[Date / Time]** and press the **SET** button.

- 5 Set the date and time.
Press \leftarrow or \rightarrow button to select the item to be set.
Press \uparrow or \downarrow button to set the date and time.

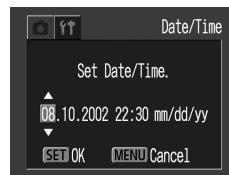

- 6 Press the **SET** button.
- 7 Press the **MENU** button.

Setting the Language

Sets the display language for LCD monitor menus and messages.

- 1 Press the **MENU** button.
The Rec. or Replay menu will display.



- 2 Press \leftarrow or \rightarrow button to select the **[SET] (Set up)]** menu.

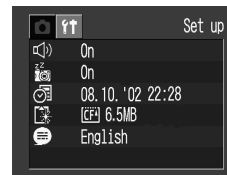

● Preparing the Camera ●

- 3** Press or button to select (Language) and press the **SET** button.



The Language menu may appear differently on cameras in some regions.

- 4** Set the language.
Press , , or button to select the language.

- 5** Press the **SET** button.
Pressing the **MENU** button without pressing the **SET** button returns to the Set up Menu without changing the language settings.

- 6** Press the **MENU** button.



Hint for Easy Operation

- The Language menu can also be displayed in replay mode by holding down the **SET** button and pressing the **MENU** button.

Using the Soft Case (Optional)

Use the soft case for storing the camera, batteries and CF card.

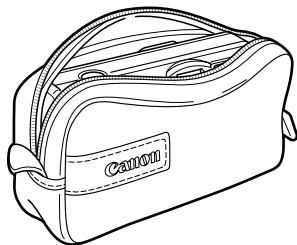

- *Soft case appearance may differ in some regions.*

Basic Functions

Turning the Power ON / OFF

Shooting Mode

- 1** Open the lens cover.
The camera powers up in Shooting mode (still).
Close the lens cover.
The power goes off.

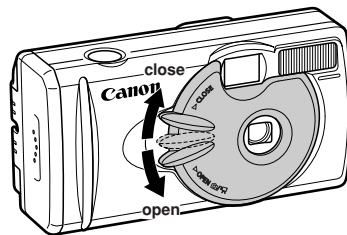

Replay Mode

- 1** Press the button until the image is displayed on the LCD monitor.
The camera powers up in Replay mode.

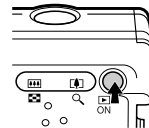

Press the button again to turn the power off.



● Power Save Function

This camera comes with a power save function.

Shooting Mode

The power will automatically shut off approximately 3 minutes after the last function is accessed.

Replay Mode

The power will automatically shut off approximately 5 minutes after the last function is accessed.

While Connected to a Printer (optional)

The power will automatically shut off approximately 5 minutes after the last camera function is accessed or printer ceases to print an image.

While Connected to a Computer

A warning message will appear on the computer screen approximately 5 minutes after the last function is accessed. The power will automatically shut off approximately 1 minute later if no functions are accessed.

- The power save function will not activate while the camera is in auto play mode (p. 63).
- The camera's settings can be changed to turn off the power save function (p. 90).
- The LCD monitor will go off in approximately 3 minutes if there are no operations performed within that time when the LCD monitor is on, even if the power save function is [Off]. Pressing any button turns the LCD monitor on again.

● **To return from power save function**
Shooting Mode

Slide the lever of lens cover down.

Replay Mode / While Connecting to a Printer / Computer

Press the  button.

Switching between Shooting/Replay

You can quickly switch between the Shooting and Replay modes. Images can be replayed and erased immediately after shooting them. Images can also be shot immediately, while images are being replayed.

Shooting Mode

- 1 Press the  button to switch to Replay mode.

Press the  button again or press the shutter button halfway to return to the Shooting mode.

Replay Mode

- 1 Open the lens cover or slide the lever of the lens cover down to switch to Shooting mode.

Using the LCD Monitor

Use the LCD monitor for shooting images, whilst checking images, for menu operations and replaying images.









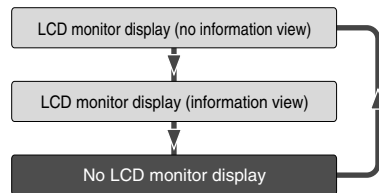

- The image in the LCD monitor may darken when the monitor is used under sunlight or other strong lighting. This is not a defect.

Shooting Mode

The display changes as shown in the following diagram when the DISP button is pressed.



- The On / Off setting of the LCD monitor display mode is memorized when the camera is turned off. When the camera is turned on again it assumes the last mode. However, when the LCD monitor is turned on and the “Change the Batteries” message appears, the LCD monitor may not automatically turn on the next time the camera is started.
- When the LCD monitor is set to On (no information display) or Off, shooting information appears for approximately 6 seconds when you take any of the following actions.
 - The power is turned on.
 - The SET, DISP,  / WB /  /  or  /  button is pressed.
 - The camera settings are changed.
 - The Set up menu is closed.
 - When the shutter button is pressed and shooting is finished (only when LCD monitor is on).
- Setting the Shooting mode to ,  or  turns the LCD monitor on regardless of whether it is set to On or Off.



- Set the flash to On or affix the camera to a tripod when the upper indicator flashes orange and the camera shake warning icon (📵) appears in the LCD monitor after the metering preparations are complete.

Replay Mode

Press the **ON** button to turn the LCD monitor on. The display changes when the DISP button is pressed.

Single Image Replay

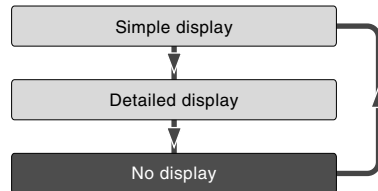

Index Replay (9 images)

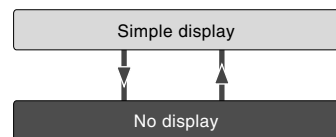

Information Displayed on the LCD Monitor

Shooting Mode

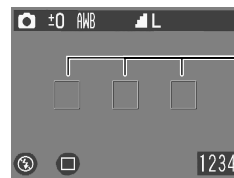

AF Frame

Number of recordable images or recordable time for movies (sec.)

Shooting Mode						p. 40
Exposure Compensation	-2 ··· ±0 ··· +2					p. 52
White Balance						p. 53
Photo Effect						p. 54
Compression						p. 41
Resolution	L	M	S			p. 41
ISO Speed	A200	ISO 50 100 200 400				p. 55
	A100	ISO 64 100 200 400				
Flash						p. 43

Shooting Method				p. 46
Macro / Infinity				p. 45
Movie Recording Mode	● (red)			p. 49
Digital Zoom	A200	x1.3 x1.6 x2.0 x2.5 x3.2 x4.0		p. 35
Setting*	A100	x1.3 x1.6 x2.0 x2.5 x3.2		
Camera Shake Warning				p. 30
Low Battery				p. 23

*Displayed during digital zoom.

The flash, continuous shoot, self-timer, macro, and infinity can be set while the shaded information is displayed. Press the DISP, / / or the / button when information is not displayed.



Notice Concerning Shooting

When using this camera to shoot scenes containing extremely bright subjects, a vertical, red bar of light may appear on the LCD monitor. It will not be recorded when shooting still photos, but will be recorded when shooting movies. This is a normal occurrence in devices containing CCDs and does not constitute a malfunction.



















Replay Mode (Simple Display)

The following information is displayed for the Simple Display.





- File no.
- Image no. (Replay image no. / total)
- Shooting date / time
- Compression (S M S)
- Resolution (L M S)
- Movie (AVI)
- Protection status (On)

Replay Mode (Detailed Display)

The following information is also displayed for the Detailed Display.

Shooting Mode	   	p. 40
Exposure Compensation	-2 ··· +0 ··· +2	p. 52
White Balance	     	p. 53
Photo Effect	    	p. 54
Flash		p. 43
Macro / Infinity	 	p. 45
Resolution (Movies)	1320 1160	p. 41

The recording time for movies is also displayed. The following information may be displayed, depending on the image.

-  Sound wave file (WAVE file) is attached.
-  An audio file other than a wavefile, or a file with unrecognized format, is attached.
-  A JPEG file not supported by “Design rule for Camera File system” standards.
-  RAW file format
-  Unrecognizable file formats



● Please note that image information recorded by this camera may not display correctly on other cameras and image information recorded by other cameras may not display correctly on this camera.

Using the Viewfinder

You can reduce power consumption by shooting images with the viewfinder.

- Align the subject with the center of the optical viewfinder and shoot. The viewfinder has a field of vision* of approximately 80% of the actual shooting image.

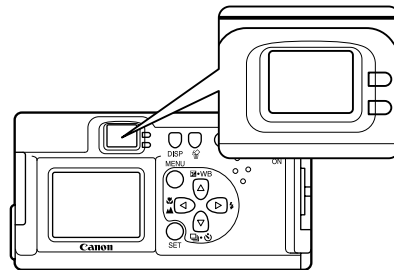

* The ratio of the range that can be viewed by the finder for the actual shooting range.



About the Autofocus Function

● This camera employs AiAF (artificial intelligence autofocus) technology which uses a broad metering field to calculate the focal distance with high precision. It delivers a crisp focus even when the photographic subject is slightly off-center (p. 51).

Image Seen in Viewfinder vs. Recorded Image

● Please note that the actual image may differ from the image seen in the optical viewfinder due to the physical separation between the viewfinder and lens. This is called the parallax phenomenon and is more noticeable the closer the subject is to the lens. In some cases, portions of images shot up close that appear in the viewfinder will not appear in the recorded image. You are recommended to use the LCD monitor to shoot images up close.

Pressing the Shutter Button

You can press the shutter button all the way down or halfway.

Pressing Halfway

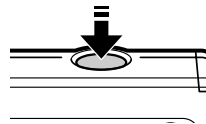

Automatically sets the exposure, focus and white balance. The camera beeps twice when settings are completed, then the upper indicator glows green (orange when the flash has been selected (p. 6).)

Pressing Fully

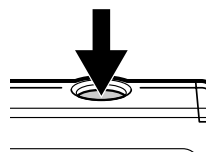

The camera beeps once, and an image is shot. An upper green indicator light flashes while the image is being recorded to the CF card (p. 6).



AF-assist Beam

- The AF-assist beam will sometimes emit when the shutter button is pressed halfway to assist focusing in certain conditions, i.e. dark conditions.
- The AF-assist beam can be turned off (p. 88). If animals are your subject, turn off the beam when shooting in the dark to avoid startling them (this may however, make it more difficult for the camera to focus).

Reviewing an Image Right After Shooting

The images that have been shot will be displayed for approximately 3 seconds*, even when the shutter button is released right after the image has been taken. You can also check the image with the following steps.

*The display time can be changed (p. 88).

- Keeping the Shutter Button pressed.
- Press the SET button while the image is displayed in the LCD monitor. Press the shutter button halfway again to stop displaying it.



- You can erase the images while they are displayed (p.65).

Using the Digital Zoom

When the LCD monitor is on, you can digitally zoom in on a subject. Images can be zoomed up to 4 times (PowerShot A200), or 3.2 times (PowerShot A100).

Adjust Zoom

 Button: The subject will be enlarged.

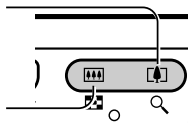

 Button: The subject will be reduced.



- The digital zoom can be set to [Off] (p. 88).
- The image will appear grainier as the image is digitally zoomed.



- Digital zoom is unavailable in some modes (p. 58).

Selecting Menus and Settings

Use the menus as shown below to operate the various shooting and replaying settings. For information on menu items and settings, see “Menu Settings and Default Settings” (p. 38).

- 1** Press the **MENU** button.
The menu appears.

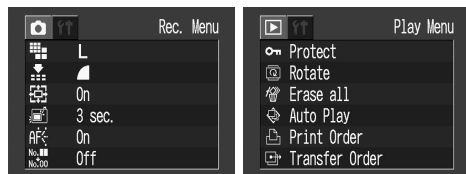

or mode

- 2** Press or button to select Rec. / Play or the Set up menu.

- 3** Press or button to select a menu item.

- 4** Rec. menu / Set up menu:
Press or button to select the settings you wish to set.
Play menu / Set up menu:
Set the details after pressing the **SET** button.

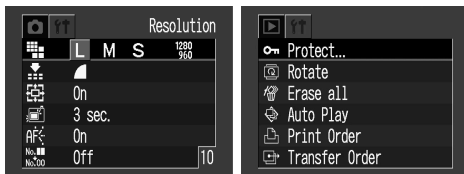

e.g. PowerShot A100

- 5** Press the **MENU** button.

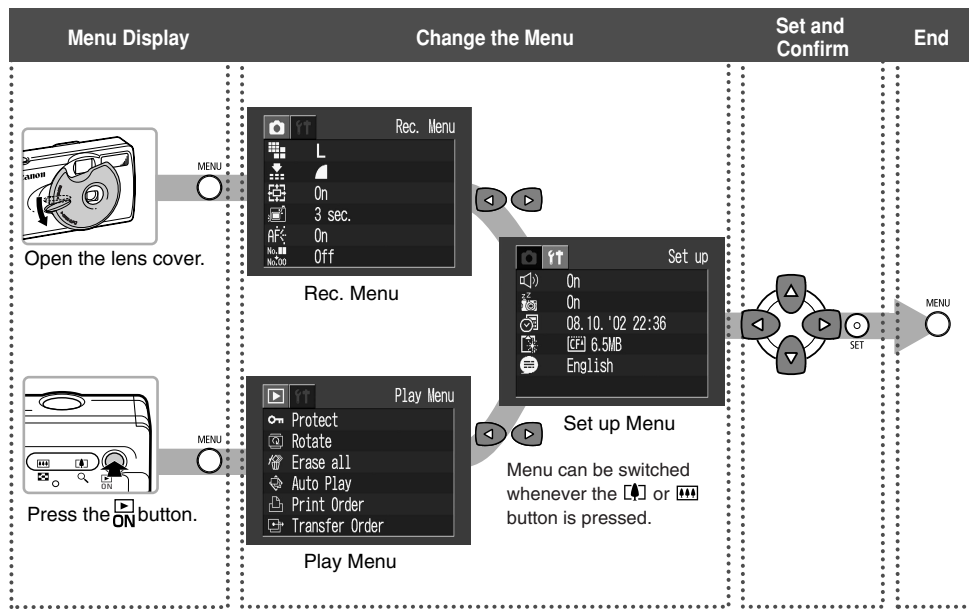

Menu Settings and Default Settings

This chart shows the options for each menu and the default settings.

	Menu Items	Available Settings	Reference Pages
Rec. Menu (Red)	Resolution (Still pictures)		
	PowerShot A200	L 1600 × 1200* / M 1024 × 768 / S 640 × 480	p. 41
	PowerShot A100	L 1280 × 960* / M 1024 × 768 / S 640 × 480	
	Resolution (Movies)	320 320 × 240* / 160 160 × 120	p. 41
	Compression	S Superfine / Fine* / Normal	p. 41
	ISO ISO Speed		
	PowerShot A200	50* / 100 / 200 / 400 / AUTO	p. 55
	PowerShot A100	64* / 100 / 200 / 400 / AUTO	
	AiAF AiAF	On* / Off	p. 51
	Digital Zoom	On* / Off	p. 35
	Review	Off / 3 sec.* / 10 sec.	p. 35
	AF AF-assist Beam	On* / Off	p. 34
No. 44 No. 00 File No. Reset	On / Off*	p. 56	

	Menu Items	Available Settings	Reference Pages
Play Menu (Blue)	Protect	Turns image protection On and Off	p. 64
	Rotate	Rotates the displayed image	p. 62
	Erase All	Erases all images	p. 65
	Auto Play	Automatically replays images	p. 63
	Print Order	Sets the print order	p. 71
	Transfer Order	Sets the transfer settings	p. 82
Set up Menu (Yellow)	Beep	On* / Off	p. 90
	Auto Power Down	On* / Off	p. 27
	Date / Time	Sets the date / time	p. 24
	Format	Formats the CF card	p. 66
	Language	English* / Deutsch / Français / Nederlands / Dansk / Suomi / Italiano / Norsk / Svenska / Español / Japanese or Chinese (depending on the region)	p. 25





* Default settings

• Some menu items are unavailable in certain shooting modes.

• The default for all of the settings changed by the menu and button operations except for [Date / Time] and [Language] can be restored all at once (p. 91).

Selecting the Shooting Mode

The following modes are available with this camera.

	Auto	The camera automatically makes most of the settings for you.
	Manual	You can manually adjust the exposure, white balance, and other settings before shooting.
	Stitch Assist	For shooting panorama composition images
	Movie	For shooting movies



The details on settings for each mode are kept even if the shooting mode is changed. When the power is turned off, the settings are also retained for certain shooting modes, but not for others (p. 57).

Selecting , , or

- 1 Open the lens cover to turn the power on. The shooting mode selected is the same as when the camera was last turned off.

- 2 Press the SET button.



- 3 Press  or  button to select the shooting mode and press the SET button.

Selecting

- 1 Whilst the lens cover is open, lower the lens cover lever to switch to movie mode. Lower the lens lever again to return to shooting still pictures.

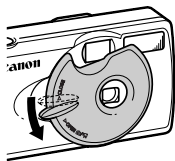

Changing the Resolution / Compression













You can change the resolution and compression (excluding movies) settings to suit your purpose.



Resolution







The resolution gets higher in the order **S** (Small), **M** (Medium), **L** (Large). Use a higher resolution if you want to make a large print. Use a lower resolution if you want to print on small objects like labels or to send images electronically or to fit more images on a CF card.



Compression

The compression gets higher in the order  (Superfine),  (Fine),  (Normal). Select  (Superfine) for a higher quality image or  (Normal) if you want to put more images on a CF card. The  (Fine) settings provide adequate quality for standard shots.

Resolution				
	PowerShot A200	PowerShot A100		
L (Large)	1600 × 1200 pixels	1280 × 960 pixels		
M (Medium)	1024 × 768 pixels	1024 × 768 pixels		
S (Small)	640 × 480 pixels	640 × 480 pixels		

Resolution	
	320 × 240 pixels
	160 × 120 pixels

Compression				
	Superfine			
	Fine			
	Normal			

- 1** In the [Rec.] Menu, select  (Resolution) or  (Compression).
See “Selecting Menus and Settings” (p. 36).

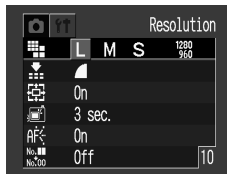

 Resolution



e.g. PowerShot A100

 Compression









- 2** Press  or  button to select the settings.









- 3** Press the **MENU** button.

- See “Functions Available in Each Shooting Mode” (p. 57).
- For information on necessary space per image (approximate), types of CF cards and the number of images per card see, “Specifications” (p. 110).

⚡ Using the Flash

	Auto	The flash fires automatically as required by the light level.
	Red-Eye Reduction, Auto	The flash may fire automatically as required by the light level. The red-eye reduction lamp fires with each shot.
	On	The flash will fire.
	Off	The flash will not fire.
	Slow-Synchro	The flash timing is adjusted to slow shutter speeds. This reduces the chance that the background will be dark when shots are taken at night or in rooms with artificial lighting. The red-eye reduction lamp fires with each shot. Use of a tripod is recommended.

- 1** Press the  button as necessary to select the desired flash mode.

			
	○	○	—
	○	○	—
	—	○	△
	○	○	△
	—	○	△

○ : Available

△ : Available only for the first image

- 2** Shoot the image.
The flash will be fired when the indicator glows orange.



- If the flash is used in macro mode, the light may not be controlled correctly. In this case, set a higher ISO sensitivity or use other lightings instead of using the flash.
- When shooting with a high ISO sensitivity and using the built-in flash, there is more of a chance of overexposure the closer you are to the subject.
- Please note that a slow shutter speed will be selected in dark places when the flash is set to off or slowsynchro. Be careful to avoid camera blur under these conditions.
 - Shooting in Mode
Be careful to hold the camera still to avoid camera Shake.
 - Shooting in or / Mode
Fix the camera to a tripod since the shutter speed will be slower than in the mode. If an image is dark in mode, reshooting in mode will make it brighter.



- The flash may take approximately 20 seconds to charge. The LCD monitor, if it is on, will go off after the indicator flashes orange while recharging. The LCD monitor will go back on after the indicator glows a

steady orange when recharging is completed. Recharging time may vary according to shooting conditions and battery charge levels.

- The flash fires twice. A preparatory pre-flash is followed by the main flash. The exposure readings obtained from the subject with the pre-flash are used to set the optimal flash intensity for the main flash, which is used to shoot the image.
- Red-Eye Reduction
Light reflecting back from the eyes may appear red when the flash is used in dark places. Use the auto red-eye reduction* for these situations.
For this mode to be effective, the subject must be looking right at the red-eye reduction lamp. Try asking them to look at the red-eye lamp. Even better results can be obtained by increasing the lighting in indoor settings or coming closer to the subject.
*The shutter will not activate for approximately 1 second after the red-eye reduction lamp fires, even when the shutter button is pressed all the way down in order to improve the effect. If you want to have more immediate shutter response, set the flash setting to either , or .

Macro / Infinity Modes



Macro

Use this mode when the distances from the lens tip to the subject is 5 to 20 cm (2 to 7.9 in.).



Infinity

Use this mode to shoot landscapes. Also use this mode for compositions combining both near and distant objects.

1

Press the button to display or .

	○	○	△	△	○
	—	○	△	△	○

○ : Available

△ : Available only for the first image

2

Shoot the image.



- If the flash is used in macro mode, the light may not be controlled correctly. In this case, set a higher ISO sensitivity or use other lightings instead of using the flash.



- Use the LCD monitor for shooting in macro mode. Subjects framed in the viewfinder when in macro mode may not appear in the final image as intended due to the parallax problem.
- The recordable area at the closest focal distance
PowerShot A200: approx. 46 x 34mm
(1.81 x 1.34 in.)
PowerShot A100: approx. 47 x 35mm
(1.85 x 1.38 in.)

Continuous Mode



The camera will shoot continuously when the shutter button is pressed. The shooting speed is as follows.*

PowerShot A200: approx. 2 images per second

PowerShot A100: approx. 3 images per second

*Large / Fine, LCD monitor off mode.

(These figures reflect standard Canon testing conditions. The actual figures will vary according to the shooting conditions.)

1 Press the / button as necessary so that appears on the LCD monitor.

2 Shoot the image.



● If internal memory becomes full, interval between shots may lengthen slightly.

● If you are using the flash, shots are taken more slowly to allow time for the flash to recharge.

Self-Timer



1 Press the / button as necessary so that appears on the LCD monitor.

2 Shoot the image.

- The self-timer starts when the shutter button is pressed. The self-timer lamp will flash. The image will be shot after approximately 10 seconds. The blinking will speed up approximately 2 seconds before the shutter activates.

Stitch Assist Mode



Use this mode when taking shots that you want to combine into a panorama. To create the panorama itself, you must stitch the images together on your computer.

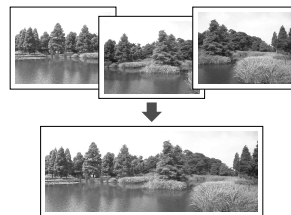

There are two stitch assist modes based on the shooting direction as shown in the following.



Left→right Shoots horizontally from left to right.



Right→left Shoots horizontally from right to left.



- To create the panorama at your computer, use the Photostitch software that came with your camera.

Framing a Subject



The PhotoStitch program detects the overlapping portions of adjoining images and merges them. When shooting, try to include a distinctive item (landmark) in the overlapping portions.



- Compose each frame so that it overlaps 30 to 50 % of the adjoining image. Try to keep the vertical misalignment to within 10 % of the image height.
- Do not include moving items in the overlap.
- Do not try to stitch images that include both distant and close items. Objects may appear warped or doubled up.

- Make the brightness in each image consistent. The final image will appear unnatural if the difference in brightness is too great.
- Pan (swivel) the camera to take successive shots.
- To shoot close-ups, slide the camera over the subject, keeping it parallel as you move.

Shooting

- 1 Shoot the first image.
- 2 Shoot the next image so that it overlaps the first image.
 - Minor discrepancies in the overlapping portions can be corrected when the images are stitched together.
 - Press the  or  button to return to a previous image that you want to reshoot.

3 Shoot the next images in the same way.



You can shoot up to 26 images.

4 Press the **SET** button to end the shooting.



- See “Functions Available in Each Shooting Mode” (p. 57).
- The settings for the first image shot are applied for all subsequent images.



Movie Mode

The resolution can be set to  320 x 240 pixels (default setting) or  160 x 120 pixels in [Resolution] of the Rec. menu (p. 41).

1 Press the shutter button all the way to start recording movie images.

- The recording time (in seconds) and a red circle appear in the LCD monitor during shooting.

2 Press the shutter button all the way again to stop the recording.

- The maximum length of individual movie clips (A200: approx. 20 frames / second, A100: approx. 15 frames / second)
 -  PowerShot A200: approx. 9 seconds
 - PowerShot A100: approx. 14 seconds
 -  PowerShot A200: approx. 26 seconds
 - PowerShot A100: approx. 30 seconds
 (based on standard conditions established by Canon)

These items may change depending on the subject or landscape conditions.

The clip will end automatically after these times have elapsed or when the CF card becomes full.



- The exposure, focus and white balance are fixed to the settings value (of the first frame) when shooting starts.
- After shooting, the green indicator flashes while recording to the CF card. You cannot shoot images at this time.



- Quick Time 3.0 or higher is required for replay movie files (AVI / Motion JPEG) on a computer. Quick Time 5.0 is included on the Canon Digital Camera Solution CD-ROM.
- See “Functions Available in Each Shooting Mode” (p. 57).

Using the Focus Lock



The following types of subject may not be suited to autofocus photography. Use the focus lock in these situations.

- Subjects with extremely low contrast to the surroundings
- Subjects with extremely bright objects at the center of the composition
- Subjects that are moving quickly
- Subjects through glass
Try to shoot as close to the glass as possible to reduce the chances of light reflecting back off the glass.

- 1 Aim the camera so that a subject at the same focal distance as the main subject is centered in the viewfinder or in the AF frame displayed on the LCD monitor.
- 2 Press and hold the shutter button halfway, and wait until the camera beeps twice.
- 3 Re-aim the camera direction to compose the shot as desired and press the shutter button all the way.

Switching Between Autofocus Modes



While the auto focus function is set to AiAF, you can change to the auto focus center point.

<input type="checkbox"/>	<input type="checkbox"/>	<input type="checkbox"/>	On	The camera automatically selects the AF frame to focus on according to the shooting conditions.
<input type="checkbox"/>			Off	Focus is selected for the center of the AF frame. This helps you to make sure that the focus is exactly where you want it.

- 1 In the [Rec.] menu, select **AiAF** (AiAF). See “Selecting Menus and Settings” (p. 36).

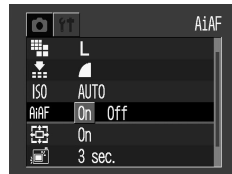

- 2 Press **[Left]** or **[Right]** button to select [On] or [Off].
- 3 Press the **MENU** button. Press the shutter button instead of the **MENU** button to shoot an image with the set auto focus mode.

Adjusting the Exposure



If you are shooting against a bright background or strong backlight, you may need to correct the exposure so that the subject doesn't come out too dark.

- 1 Press the / **WB** / button.

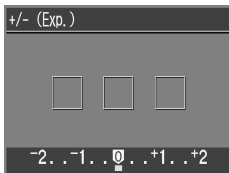

- 2 Press or button to adjust the compensation.
 - You can set the adjustments from -2 to +2 in 1/3-step increments.

- 3 Press the **SET** button.
If you wish to turn compensation off, set the compensation value to 0.

- You can check the results of the compensation by viewing the image on the LCD monitor when it is on.
- You can shoot another image immediately after making a setting. You can check the result of your setting as the image will be displayed again after shooting.

WB Setting the White Balance



When the white balance is set to match the light source, the camera can reproduce colors more accurately.

	Auto	The camera sets the white balance automatically according to shooting conditions.
	Daylight	Use when shooting outdoors in sunlight on a clear day.
	Cloudy	Use when shooting outdoors and the sunlight is not enough such as under cloudy skies, in shade or at dusk.
	Tungsten	For recording under tungsten and bulb-type 3-wavelength fluorescent lighting.
	Fluorescent	For recording under warm-white, cool-white or warm-white (3-wavelength) fluorescent lighting.
	Fluorescent H	For recording under daylight fluorescent, or daylight fluorescent-type (3-wavelength) fluorescent lighting.

- 1 Press the / **WB** / button (several times) until the white balance setting screen appears.



- 2 Press or button to select white balance.
 - If the LCD monitor is on, you can check the results by viewing the image on the LCD monitor.
 - A shot can be taken immediately by pressing the shutter button. The menu will reappear after the shot, allowing you to adjust the setting.







- 3 Press the **SET** button.





- The white balance cannot be set when (sepia) or (B/W) photo effect is selected.



Switching Between Photo Effect Modes

An image can be recorded in a different Photo Effect Mode.

	Off	Records normally with this setting.
	Vivid	Emphasizes the contrast and color saturation to record in bold colors.
	Neutral	Tones down the contrast and color saturation to record neutral hues.
	Low Sharpening	Records subjects with softened outlines.
	Sepia	Records images in sepia tones.
	B/W	Records images in black and white.

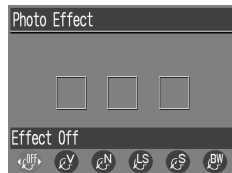
- 1 Press the  / **WB** /  button (several times) until the photo effect setting screen appears.



- 2 Press the  or  button to select the photo effect.

- If the LCD monitor is on, you can check the photo effect by viewing the image on the LCD monitor.
- A shot can be taken immediately by pressing the shutter button. The menu will reappear after the shot, allowing you to adjust the setting.

- 3 Press the **SET** button.



Changing the ISO Speed

Change the ISO speed when shooting images in dark places or when you want to raise the shutter speed.

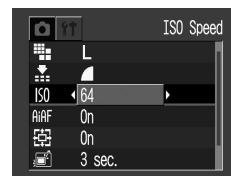
- 1 In the [Rec.] menu, select **ISO** (ISO Speed).
See “Selecting Menus and Settings” (p. 36).



e.g. PowerShot A100

- 2 Press the  or  button to select the ISO speed.
- 3 Press the **MENU** button.



- Higher ISO speeds increase the image noise. To take clean images, use as low an ISO speed as possible.
- When [AUTO] is selected, the camera automatically adjusts ISO as shown below.
PowerShot A200: ISO 50 - 150
PowerShot A100: ISO 64 - 150

Resetting the File Number



Select the set up method for the file number.

On	The camera resets the file number to 100-0001 each time you insert a new (unused) CF card. If you insert a card that already contains some images, numbering resumes from the next available number.
Off	The camera remembers the last file number, and starts numbering from the next number when you insert a new CF card.

1 In the [Rec.] menu, select (File No. Reset).

See “Selecting Menus and Settings” (p. 36).



2 Press or button to select [On] or [Off] and press the **MENU** button.



- The [Off] setting helps ensure that file numbers remain unique over multiple CF cards. This is useful if you are planning to download images from the cards to your computer, since it helps avoid accidental overwrites that may occur if filenames are duplicated.

About file numbering...

- Image files are assigned numerical file names over the range 0001 to 9900. The camera stores these files into folders, which are assigned folder numbers from 100 to 998 (except that numbers ending in 99 are not used).
- In most cases the camera stores exactly 100 files into each folder. Because the camera cannot switch to a new folder when taking shots in or / mode, however, some folders may have more than 100 images.

Functions Available in Each Shooting Mode

The following chart shows the functions and settings available in each shooting mode. The camera stores settings separately for each mode, and retains these settings even if you switch to a different mode.

	Function					Reference Pages
Resolution	Large	○*	○*	△*	—	p. 41
	Medium	○	○	△	—	
	Small	○	○	△	—	
	Movie	—	—	—	○*	
	Movie	—	—	—	○	
Compression	SuperFine	○	○	△	—	p. 41
	Fine	○*	○*	△*	—	
	Normal	○	○	△	—	
Flash	Auto	○	○	—	—	p. 43
	Red-eye reduction, Auto	○*	○*	—	—	
	On	—	○	△	—	

Continues on next page

Function							Reference Pages
Flash	Off	○	○	△*	○*	p. 43	
	Slow-Synchro	—	○	△	—		
Macro Mode		○	○	△	○	p. 45	
Infinity Mode		—	○	△	○	p. 45	
Shooting Method	Single	○*	○*	△*	○*	p. 46	
	Continuous	—	○	—	—		
	Self-Timer	○	○	△	○		
Exposure Compensation		—	○	△	○	p. 52	
White Balance		—	○	△	○	p. 53	
Photo Effect		—	○	△	○	p. 54	
ISO Speed		— ⁽¹⁾	○	— ⁽¹⁾	— ⁽¹⁾	p. 55	
Auto Focus Frame		—	○	—	—	p. 51	
Digital Zoom		○	○	—	—	p. 35	
AF-assist Beam		○	○	△	○	p. 34	

* : Default settings ○ : Available △ : Available only for the first image

⁽¹⁾: The ISO speed is automatically set between the equivalent of 50 and 150 (PowerShot A200) or 64 and 150 (PowerShot A100)

: Setting is retained even after power off.

Replaying

Displaying Images Individually

Use this feature to view recorded images one at a time on the LCD monitor (Single Image Replay).

- 1 Press the button.
The last image shot is displayed.
- 2 Press or button to switch the displayed image.
Hold down or button to display images continuously.

Magnifying Images

- 1 Press the button during single replay.
The image enlarges gradually by up to 10 times.



Approximate Location of the Magnified Area

- When you hold down the **SET** button and press the button, the image enlarges in the order: approximately 2.5 times → approximately 5 times → approximately 10 times.
- Press , , or buttons to change the display position vertically and horizontally.
- To return to normal-size display, press the button.







- Movies cannot be enlarged.

Viewing Images in Sets of 9



View nine images at once on the LCD monitor (Index View) so that you can search the image quickly.

- 1 Press the  button. 9 images appear at a time.





- 2 Press , ,  or  button to select the image.
- 3 Press the  button for an image you want to zoom.

Changing the Displayed Images





- 1 Press the  button while the index is being replayed.
- 2 Press  or  button to change the image.



- Hold the **SET** button and press the  or  button to jump to the first or last image.
- Press the  button to go to index replay.

Viewing Movies

Replay movies you shot.

- 1 Press  or  button to select the movie.
A movie displays with the instructions   /  on it.





- 2 Press the **SET** button.
The movie is replayed.
 - When a movie has finished replaying, it will display the last frame. Pressing the **SET** button again in this state will start replaying from the first frame.

Pausing and Resuming Play

- Press the **SET** button to pause the movie. Press it again to resume play.

Fast Forwarding / Rewinding

- Press  or  button to stop the movie and display the previous or next image or movie.



- You may experience frame dropping when replaying a movie on a computer with insufficient system resources.

Rotating Images in the Display

You can rotate an image by 90° or 270° clockwise in the LCD monitor.



0° (Original)





90°



270°

1 In the [Play] Menu, select  (Rotate) and press the **SET** button.
See “Selecting Menus and Settings” (p. 36).

2 Press  or  button to select the image to be rotated and press the **SET** button.

Press the **SET** button to rotate the Image 90°, 270° and back to original orientation.

3 Press the **MENU** button.





- Movie images cannot be rotated.
- If an image has been rotated in the camera before being loaded onto a computer, the particular software in use will determine whether or not the rotation settings are retained.

Auto Play

Use this feature to automatically replay all of the images in the CF card (Auto Play). The LCD monitor displays each image for approximately 3 seconds.

1 In the [Play] Menu, select  (Auto Play) and press the **SET** button.
See “Selecting Menus and Settings” (p. 36).

Auto play starts.

- As with the single image display mode, pressing the  or  button during auto play will advance through the images more rapidly.

Pausing and Resuming Auto Play

You can pause Auto Play at any time by pressing the **SET** button. You can then restart it by pressing the **SET** button again.

Stopping Auto Play





To stop Auto Play, press the **MENU** button.



- The display interval may vary for some images.
- Movie images play for the length of time that they were recorded.
- The power save function is disabled during Auto Play (p. 27).

Protecting Images

Use the protect feature to protect important images from accidental erasure.

- 1 In the [Play] Menu, select  (Protect) and press the **SET** button.
See "Selecting Menus and Settings" (p. 36).
- 2 Press  or  button to select the image you want to protect and press the **SET** button.
The  icon appears on the protected image.



 Protected Icon

- To release the protection, press the **SET** button again.
- You can make the selection of images easier by toggling between single replay and Index replay with the  button.

3 Press the **MENU** button.





● Please note that even protected images are erased when a CF card is reformatted.

Erasing





- Remember that erased images cannot be recovered. Be careful to avoid accidental erasures.
- This function will not erase protected images (p. 64).

Erasing Images Individually

- 1 Press the  or  button to select the image you want to erase and press the  button.





- 2 Press the  or  button to select [OK] and press the **SET** button. Select [Cancel] instead of [OK] and press the **SET** button if you decide you do not want to erase the image.

Erasing All Images

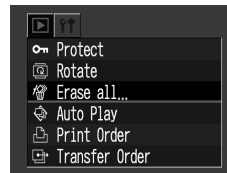
- 1 In the [Play] Menu, select  (Erase all) and press the **SET** button.
See "Selecting Menus and Settings" (p. 36).



- 2 Press  or  button to select [OK] and press the **SET** button. Select [Cancel] instead of [OK] and press the **SET** button if you decide you do not want to erase the images.



Formatting a CF Card



You should format new CF cards before using them.



- Formatting a CF card will permanently erase all data already on it, including all of its protected images. Check the contents before formatting cards that were previously used.

- 1 In the [Set up] Menu, select  (Format) and press the **SET** button. See “Selecting Menus and Settings” (p. 36).
- 2 Press  or  button to select [OK] and press the **SET** button.



Select [Cancel] and press the **SET** button to cancel the formatting.



- If the camera is not operating correctly, the CF card may be corrupted. Formatting the card may solve the problem.
- If you are using a CF card from another manufacturer and the card is not functioning correctly, you may be able to correct the problem by formatting the card.
- CF cards formatted with another camera, a computer or peripheral device may not operate correctly. Format these cards with this camera. If formatting in the camera doesn't work properly, turn the camera off and re-insert the CF card. Then turn the camera back on and format again.

Printing

About Printing

After connecting the camera to an optional Canon direct print function compliant printer, you can easily print images just by using the controls on the camera. Or, you can specify the images on your CF card you want to print and how many copies you want (DPOF* Print Settings), and then take the CF card to a participating photo lab to have them printed out later.

Refer to the System Map included with this camera kit for printer information.

* Digital Print Order Format

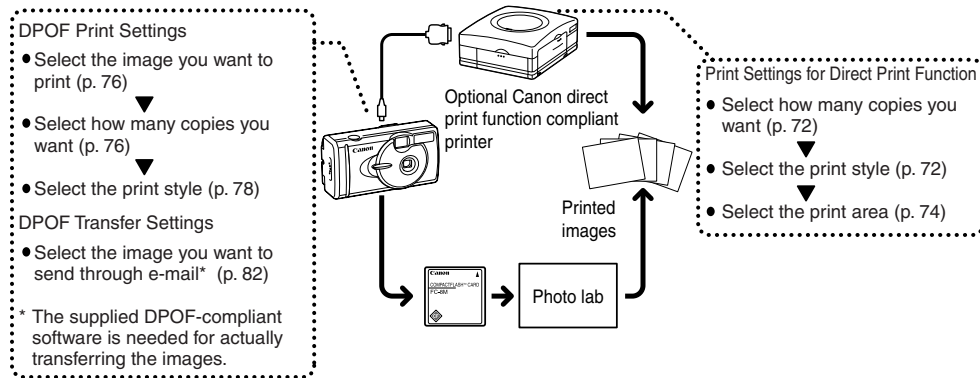

Selecting from the Print Order Menu

Use the Print Order Menu as shown below to select all print settings.

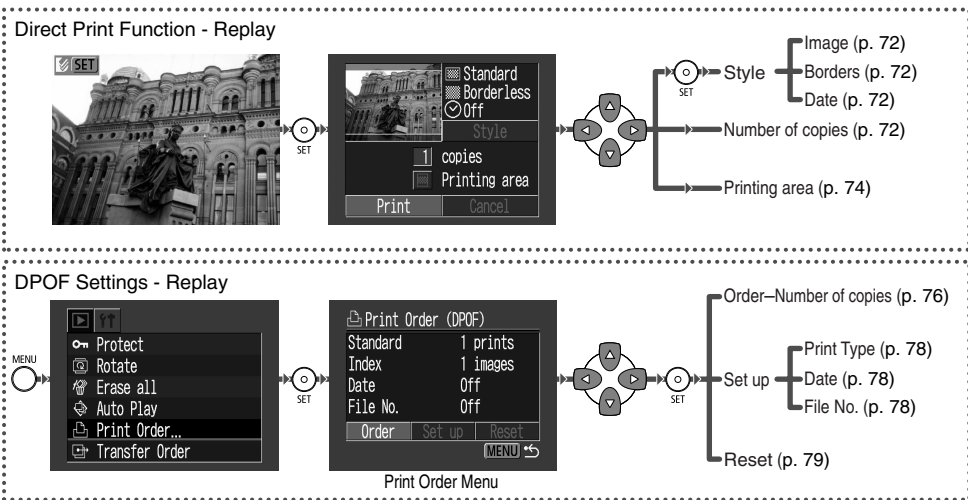

Connecting the Camera to a Printer

Two direct interface cables are included with Canon printers having the direct print function. Use the DIF-100 cable with the  mark on the connector when connecting to this camera.



● If you plan to print out many prints in a single session, it is recommended that you power the camera with AC power (p. 99) or else load fully charged NiMH batteries (p. 96) or unused alkaline batteries before you begin.



- Refer to the System Map included with this camera kit for printer information.
- Please see your printer's user guide for instructions on loading paper and installing an ink cassette.

1 Turn off the Camera.

2 Attach the power cable to the printer and plug the other end into power supply. Or, install the printer's rechargeable battery.

- Depending on the type of printer you have, it may or may not use rechargeable batteries. Refer to your printer's user guide.

3 Connect the camera and printer using the direct interface cable.

- When you insert the cable, make sure the  mark of the cable faces the front of the camera.

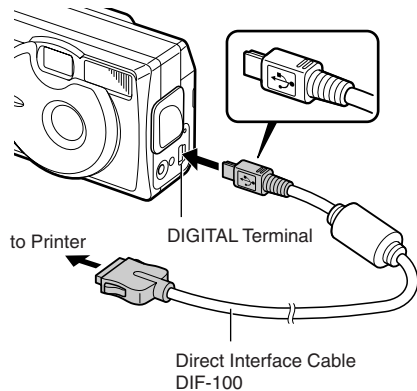

Direct Interface Cable
DIF-100

4 Press the button to turn the camera power on.

If the printer is correctly connected, the  icon will appear on the LCD monitor.





- When disconnecting the cable from the camera's Digital terminal, be sure to hold the connector at its sides and pull it straight out.



- Movies cannot be played back or the language cannot be set with **SET + MENU** button when the camera is connected to a printer.
- When the printer is disconnected, the  symbol will disappear from the LCD monitor and the camera will revert to standard replay mode.

Printing

An image can be printed when displayed in single replay or selected in index replay.

- Press  or  button to select the image you wish to print, and then press the **SET** button.
- Set the number of prints, the print style (p. 72) and printing area (p. 74) settings as required.
- Select [Print] and press the **SET** button.



The image will start to print and, when it is completely finished, the display will revert to the replay screen.





- Movies cannot be printed.



Cancel Printing

- Press the **SET** button while printing. A confirmation screen will appear. Press  or  button to select [OK] and press the **SET** button.
- A print in progress cannot be stopped. Wait until the current image is printed and then cancel before the next one starts. The display will revert to standard replay mode.

Printing Errors

- The error screen is displayed when errors occur during printing (p. 94). Press  or  button to select [Cancel] or [Resume] and press the **SET** button.
- [Resume] may not appear depending on the error details. Select [Stop] in these instances.

Print Settings (Direct Print Function)

You can specify print settings while a printer is connected.

Setting the Number of Copies

- While displaying the image, press the **SET** button and press Δ or ∇ button to select [copies].



- Set the number of copies with \leftarrow or \rightarrow button.
You can set from 1 to 99 prints.

Setting the Print Style

You can set the following print styles.

Image	Standard	Prints one image per page.
	Multiple*	Prints eight copies of the same image on one page.
Borders	Borderless	Prints right to the edge of the page.
	Bordered	Prints with a border.
Date		Prints the image's creation date.

*This setting is only available for Card-Size paper.

- While displaying the image, press the **SET** button. Press Δ or ∇ button to select [Style], then press the **SET** button.



- Press Δ or ∇ button to select [Image], [Borders], or [Date].



- Select with \leftarrow or \rightarrow button.

- Image**
Select [Standard] or [Multiple].



- Borders**
Select [Borderless] or [Bordered].



- Date**
Select [On] or [Off].



4 Press the **MENU** button.

- If [Borderless] or [Multiple] is selected as the print style, the center portion of the recorded image is printed at an enlarged size. As a result, the top, bottom and sides may be cropped slightly. The area of the image that will be printed will appear lighter than the rest of the image allowing you to check the portion to be cropped.



- Date and borders cannot be set when [Multiple] is selected. (The image will be printed with the Date set to [Off] and the Borders set to [Borderless].)
- With the [Bordered] option, the border is printed in practically the same space as the recorded image.

Specifying the Printing Area

You can select from 3 types of printing areas.



Before specifying the printing area

- Please set the Print Style (Image, Borders and Date) first (p. 72).
- Printing area can only be specified with the borderless and multiple print style.

1 While displaying the image, press the **SET** button. Press **⏪** or **⏩** button to select [Printing area].



2 Press **⏪** or **⏩** button to select the printing area from , or .





- The selectable print area may move left or right for L size paper or when the screen setting for the print style is [Multiple].
- The printing area setting only applies to one image.
- The printing area setting is cancelled with the following operations.
 - Printing
 - When you set the printing area setting for another image.
 - When you close the Print mode, i.e.
 - turn the camera off
 - change the camera mode
 - after setting the printing area, you select [Cancel] and don't print
 - detach the DIF-100 direct Interface cable

DPOF Print Settings

On your CF card, select which image or images you want to print and how many copies you want. This is convenient for printing images all at once, on optional Canon direct print function compliant printers or at participating photo labs.

Selecting Images for Printing

- 1 Display the [Print Order] menu.
See “Selecting from the Print Order Menu” (p. 68).
- 2 Select [Order] and press the **SET** button.
- 3 Press \leftarrow or \rightarrow button to select the image.
 - ▶ For setting images one by one
The setting method will vary according to the print type settings () (p. 78) as shown in the following.

-  (Standard) /  (Both)

You can now select the number of copies with \uparrow or \downarrow button. (Max. 99 copies)



-  (Index)

Press \uparrow or \downarrow button to place a check mark for selecting the image and press it again to remove the checkmark for deselecting.

You can set with the same method even if the  button is pressed and changed to index replay (3-image index replay).



▶ For setting all images on the CF card

- Press the  button to switch to index replay (3-images display)
- After pressing the **SET** button, press \uparrow or \downarrow button to select [Mark all]. Press the **SET** button again to set for printing all images one at a time.

- You can change the number of copies for each image when the print type is [Standard] / [Both]. You can remove the print settings when the print type is [Index]. See from Step 3 for changing the settings.
- Select [Clear all] to remove all settings.

4

Press the **MENU** button.



- The  mark appears on images that have had print marks set by another DPOF-compliant camera. These settings will be overwritten by any print marks set by your camera.
- The output of some digital printers or photo lab services may not reflect the specified print settings.
- Movies cannot be printed.



- Images are printed in order from oldest to newest by the shooting date.
- A maximum of 998 images can be set per CF card.
- The number of copies cannot be set when the [Print Type] is set to [Index]. Only one copy can be set at [Index].
- Print settings can also be assigned to images with the bundled software programs on a computer.

Setting the Print Style

You can set up the print style as follows.

	Print Type	<ul style="list-style-type: none"> Standard: Print one image per sheet. Index: Print index prints (multiple reduced-size images per page). Both: Print selected images both in standard and index format.
	Date	Include the date on the print.
	File No.	Include the file number on the print.

- 1 Display the [Print Order] menu. See “Selecting from the Print Order Menu” (p. 68).
- 2 Press or button to select [Set up] and press the **SET** button.
- 3 Press or button to select the print style (, or).
- 4 Select with or button.

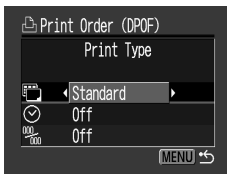

(Print Type)
Select [Standard], [Index] or [Both].

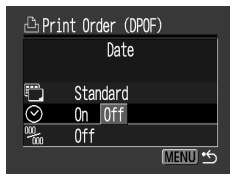

Date
Select [On] or [Off].

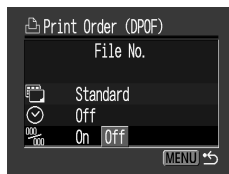

File No.
Select [On] or [Off].

- 5 Press the **MENU** button.



- If you have chosen (index) as the print type, you cannot set [Date] and [File No.] to [On] at the same time.
- If you have chosen [Both] as the print type, you can set both [Date] and [File No.] to [On], however, only the file numbers will be printed on index prints.



- The date is printed in a style set by (p. 24).

Resetting the Print Settings

The Reset feature clears all print selections, and resets Print Type to [Standard], Date to [On], and File No. to [Off].

- 1 Display the [Print Order] menu. See “Selecting from the Print Order Menu” (p. 68).
- 2 Press or button to select [Reset] and press the **SET** button.

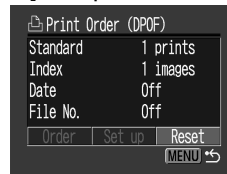

- 3 Press or button to select [OK] and press the **SET** button. Select [Cancel] and press the **SET** button to cancel the reset.

Printing with DPOF Print Settings

You can use the DPOF print settings to print with an optional direct print function compliant printer.

- 1 Display the [Print Order] menu.
See “Selecting from the Print Order Menu” (p. 68).
- 2 Press or button to select [Print] and press the **SET** button.

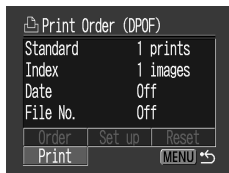

- 3 Set the print style as required.
 - See “Setting the print style” (p. 72)
 - A print style cannot be set if the print type is set to [Index] in the DPOF print setting.
- 4 Press , , or buttons to select [OK] and press the **SET** button.
The image will start to print and, when it is completely finished, the display will revert to the replay screen.

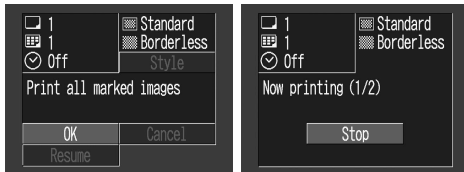

- To print the date, set the [Date] setting in the print order menu in Step 2 on the previous page to [On]. You cannot set the date to print with the [Style] menu in Step 3 on the previous page (p. 78). If the print type is set to [Index], the date will not print even if the [Date] setting is set to [On] in Step 2.
- When [Print Type] is set to [Standard], the file number is not printed.



- When the Print Type is set to [Index], the number of images that will be printed depends on the size of the paper.
 - Card Size: 20 images
 - L Size: 42 images
 - Postcard Size: 63 images
- Cancel Printing (p. 71)
- Restarting Printing
 - In the Print Order menu, select [Resume] using or button and press the **SET** button. The remaining images can be printed.
 - Printing cannot be restarted under the following circumstances.

- If the print settings have been changed before restarting.
- If the image for which the print settings were set has been deleted before restarting.
- If there was very little free space on the CF card when the printing was cancelled.

If these circumstances apply, you can select [OK] in the print screen and reprint starting from the first image. If printing was cancelled because the camera batteries became discharged, please power the camera with a household power source or change to fully charged AA-size NiMH or unused alkaline batteries, then turn the camera on.

- Printing Errors (p. 94)



Setting the Image Transfer

Using the camera, you can specify images you wish to transfer and attach to e-mails. (Please use the supplied software for actually transferring images.) These settings are compatible with the Digital Print Order Format (DPOF) standards.



- The  mark will display on images that have had transfer marks set by another DPOF-compliant camera. These settings will be overwritten by any marks set by your camera.

Selecting Images for Transferring





- 1** In the [Play] menu, select  (Transfer Order) and press **SET** button. See “Selecting Menus and Settings” (p. 36).
- 2** Press  or  button to select [Order] and press the **SET** button.



- You can remove all the transfer marks at once by selecting [Reset].



3 Select images for transferring.

▶ For setting images one by one

- Press  or  button to select the image and mark or remove from images using  or  button. The check marks are displayed when set.
- Pressing the  button allows you to set with the same method even if changed to index replay (3-images).



▶ For setting all images on the CF card

- Press the  button to switch to index replay (3-images display).
- After pressing the **SET** button, press  or  button to select [Mark all]. Press the **SET** button again to set for printing all images one at a time.

4



Press the **MENU** button.

- Images are transferred in order from oldest to newest by the shooting date.
- A maximum of 998 images can be marked per CF card.
- Transfer settings can also be assigned to images with the supplied software programs on a computer.

Downloading Directly from a CF Card

- 1 Eject the CF card from the camera and insert it into a CF card reader.

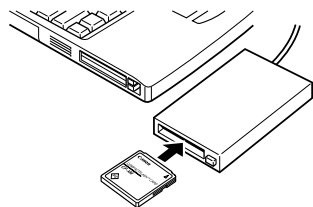

- If you are using a PC card reader, first insert the CF card into a PC card adapter (optional), and then insert it into the computer's PC card reader.

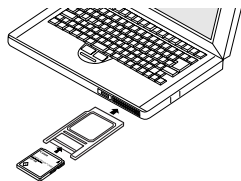

- 2 Double-click the icon of the drive connected with the CF card to open the drive.

- 3 Copy images from the card into a folder of your choice on the hard disk. The images are stored in the [xxx CANON] folders located in the [DCIM] folder (where xxx is a three-digit number from 100 to 998).



- Some computers or PC card readers require the power to be off when the CF card or PC card adapter is inserted. Since this requirement varies between models, please consult the manual for your equipment.

Connecting the Camera to a Computer Via the USB Cable

Installing the included software in advance allows you to download images automatically simply by connecting the camera to the computer with the included USB cable.

- 1 Connect the supplied USB interface cable to the computer's USB port and the camera's Digital terminal.

- You do not need to turn off the computer or camera when making this connection.
- Please refer to your computer manual for information regarding the location of the USB port.

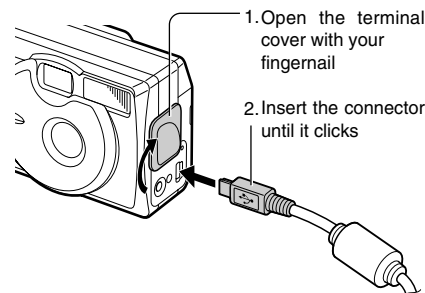
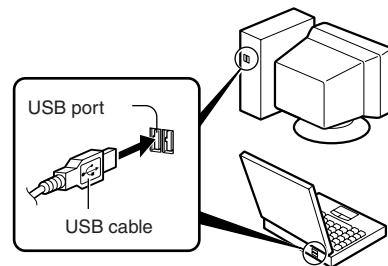



● Downloading Images to a Computer ●

- 2** Press the  button. The LCD monitor displays in replay mode. When the connection to the computer is complete, the LCD monitor turns off and the green indicator comes on.

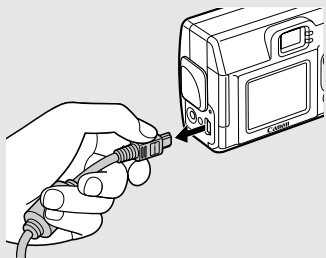

- To disconnect the cable from the camera: Hold the cable connector firmly at both sides and pull it straight out.





- It is recommended to power the camera from a household power outlet with the optional AC Adapter Kit ACK 800 when connected to a computer (p. 99).
- If you disconnect the USB cable while the camera is on, the camera will automatically turn off.
- If you leave the camera unused for approximately 5 minutes while it is connected to the computer, the computer screen displays a warning message. If you do not take any action within the next minute, the camera turns off. You can turn the camera back on by pressing the  button.



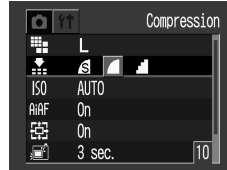

For more information about what to do after connecting your camera, please refer the *Software Starter Guide*.

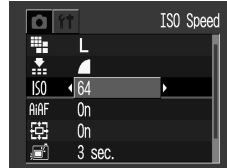
List of Menu Options and Messages

Rec. Menu (1/2)

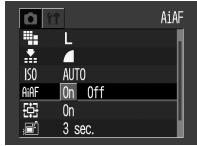
		*Default settings													
Item / Menu Screen	Setting Content	Item / Menu Screen	Setting Content												
Resolution (Still images)	Sets the number of pixels used to record images to CF cards (p. 41). <ul style="list-style-type: none"> L Large* PowerShot A200 (1600 × 1200 pixels) PowerShot A100 (1280 × 960 pixels) M Medium (1024 × 768 pixels) S Small (640 × 480 pixels) 	Compression	Sets the relative compression ratio used to record images to CF cards (p. 41). <ul style="list-style-type: none"> S Superfine Fine* Normal 												
	e.g. PowerShot A100														
Resolution (Movies)	Set the resolution of the frames as they are recorded to the CF card (p. 41). <ul style="list-style-type: none"> 1320 (320 × 240 pixels)* 1160 (160 × 120 pixels) 	ISO Speed	Sets the recording sensitivity (p. 55). <table border="0" style="width: 100%;"> <tr> <td>(A200)</td> <td>(A100)</td> </tr> <tr> <td>• 50*</td> <td>• 64*</td> </tr> <tr> <td>• 100</td> <td>• 100</td> </tr> <tr> <td>• 200</td> <td>• 200</td> </tr> <tr> <td>• 400</td> <td>• 400</td> </tr> <tr> <td>• AUTO</td> <td>• AUTO</td> </tr> </table>	(A200)	(A100)	• 50*	• 64*	• 100	• 100	• 200	• 200	• 400	• 400	• AUTO	• AUTO
(A200)	(A100)														
• 50*	• 64*														
• 100	• 100														
• 200	• 200														
• 400	• 400														
• AUTO	• AUTO														
			e.g. PowerShot A100												

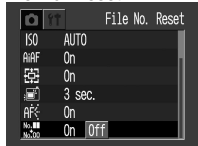

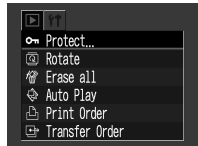
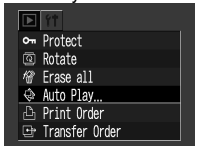
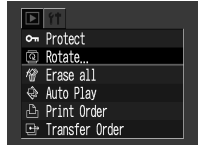
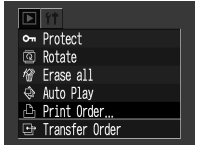
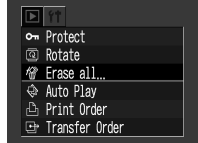
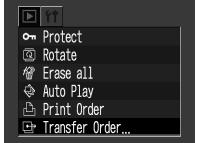

Rec. Menu (2/2)

Item / Menu Screen	Setting Content	Item / Menu Screen	Setting Content
<p>AiAF</p> 	<p>Sets the AiAF to on (the camera automatically selects the AF frame when taking a picture) or off (AF frame is set to the middle frame) (p. 51).</p> <ul style="list-style-type: none"> • On* • Off 	<p>AF-assist Beam</p> 	<p>Turns the AF-assist beam on or off (p. 34).</p> <ul style="list-style-type: none"> • On* • Off
<p>Digital Zoom</p> 	<p>Turns the digital zoom on or off (p. 35).</p> <ul style="list-style-type: none"> • On* • Off 	<p>File No. Reset</p> 	<p>Sets how file numbers are assigned to images (p. 56).</p> <ul style="list-style-type: none"> • On • Off*
<p>Review</p> 	<p>Sets the duration images display on the LCD monitor after the shutter button is released (p. 35).</p> <ul style="list-style-type: none"> • Off • 3 sec.* • 10 sec. 		

Play Menu

Item / Menu Screen	Setting Content	Item / Menu Screen	Setting Content
<p>Protect</p> 	<p>Protects images from accidental erasure (p. 64).</p>	<p>Auto Play</p> 	<p>*Default settings Plays images automatically one after the other (p. 63).</p>
<p>Rotate</p> 	<p>Rotates images 90 or 270 degrees clockwise in the display (p. 62).</p>	<p>Print Order</p> 	<p>Sets which images and how many copies will be printed on a direct print function compliant printer or a photo lab service (p. 76).</p>
<p>Erase all</p> 	<p>Erases all images from a CF card (excluding protected images) (p. 65).</p>	<p>Transfer Order</p> 	<p>Sets the images that will be transferred with your e-mail software (p. 82).</p>

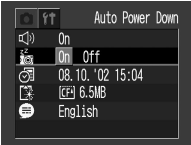
Set up Menu

Item / Menu Screen	Setting Content	Item / Menu Screen	Setting Content
<p>Beep</p> 	<p>Sets whether or not the beep sounds when the shutter button is pressed or when a menu operation is performed (p. 34).</p> <ul style="list-style-type: none"> • On* • Off • Still beeps to warn of an error even when set to Off. 	<p>Format</p> 	<p>*Default settings</p> <p>Formats (initializes) a CF card (p. 66).</p>
<p>Auto Power Down</p> 	<p>Sets whether or not the camera automatically powers down after a specified period of time elapses without something being pressed (p. 27).</p> <ul style="list-style-type: none"> • On* • Off 	<p>Language</p> 	<p>Sets the language used in the menus and messages on the LCD monitor (p. 25).</p> <p>English / Deutsch / Français / Nederlands / Dansk / Suomi / Italiano / Norsk / Svenska / Español / Japanese or Chinese (depending on the region)</p>
<p>Date/Time</p> 	<p>Sets the date, time and date format (p. 24).</p>		

Resetting the Settings to Default

You can reset all of the menu and button operation settings to default except for [Date / Time] and [Language].

- 1 Turn on the camera.
Can be performed from shooting, replay or any other mode.
- 2 Press the **MENU** button for longer than 5 seconds.
The message "Reset settings to default?" appears on the LCD monitor.

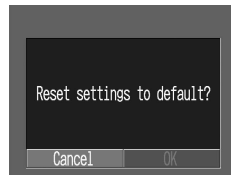

- 3 Press \leftarrow or \rightarrow button to select [OK], and press the **SET** button.
The screen below appears while resetting. The normal screen resumes when resetting is complete.

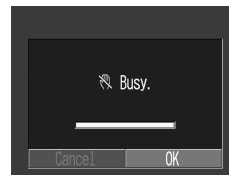

- To cancel resetting, select [Cancel] instead of [OK].

List of Messages

The following table explains each of the messages that may appear on the LCD monitor.

Busy...	: The camera is recording image data to the CF card. The Replay mode is running.
No CF card	: You attempted to shoot or replay with no CF card installed.
Cannot record!	: You attempted to shoot with no CF card installed.
CF card error!	: There is something wrong with the CF card.
CF card full	: The CF card is too full to store images or accept new print settings.
Naming error!	: The camera cannot generate a file name for the image you have shot because the card already contains a folder having the same name as the file to be created, or the file number has already reached the maximum possible value. Display the Rec. menu and set [File Number Reset] to [On]. Save all images you wish to keep into your computer, and reformat the CF card. Please note that formatting will erase all data in the card.
Change the batteries	: The batteries are dead, and the camera can no longer function. Replace both batteries at the same time with new AA-size alkaline batteries (p. 19) or fully recharged batteries.
No image	: No images recorded on CF card.

Image too large	: You attempted to replay an image whose resolution exceeded 3200 x 2400 pixels or whose file size was too large.
Incompatible JPEG format	: You attempted to replay an incompatible JPEG file.
Corrupted data	: You attempted to replay an image with corrupted data.
RAW	: You attempted to replay an image recorded in the RAW format.
Unidentified image	: You attempted to replay an image file recorded in a unrecognized format (file recorded by a different camera in a proprietary format, etc.).
Cannot magnify!	: The image you attempted to magnify was recorded by another camera, or recorded in a format that cannot be magnified, or edited on a computer.
Cannot rotate!	: The image you attempted to rotate was recorded by another camera, or recorded in a format that cannot be rotated, or edited on a computer.
Protected!	: You attempted to erase a protected image.
Too many marks!	: Too many images have been marked for printing. No more images can be marked.
Unselectable image	: You attempted to set the print settings for a non-JPEG file.
Exx	: Camera malfunctioned. Turn off the power and turn on again, then re-shoot or replay. If the same message recurs frequently, the camera may be damaged. Note down the error number [xx] and take the camera to a Customer Support Help Desk. If this message appears immediately after you have taken a shot, the camera may not have shot the image. Switch to the Replay mode and check whether the image was actually recorded.

● List of Menu Options and Messages ●

The following table lists and explains the messages that may be on the LCD monitor when printing to an optional direct print function compliant printer. (Some of these messages may not appear depending on the printer.)

No Paper	: Paper cassette is empty or is not installed correctly.
No Ink	: No ink cassette in the printer, or the ink cassette is out of ink.
Incompatible paper size	: You attempted to print with a paper size incompatible with this camera.
Incompatible ink size	: You attempted to print with an ink cartridge type incompatible with this camera.
Ink Cassette Error	: There is a problem with the ink cassette.
Paper and ink do not match	: The paper size and ink type are from different sets.
Paper Jam	: Paper jammed during printing.
Paper has been changed	: The paper size was changed between the time the Print Style menu was displayed and the time printing started.
Ink has been changed	: The ink type was changed between the time the Print Style menu was displayed and the time printing started.
Recharge the printer battery	: The printer's battery is out of power.
Communication Error	: A communication error has occurred.
Cannot Print!	: You attempted to print an image shot by a different camera, or in an incompatible format, or downloaded to and edited on a computer.
Could not print xx images	: You attempted to print xx number of images with DPOF settings that were shot by a different camera, or in an incompatible format, or downloaded to and edited on a computer.

Appendices

Replacing the Date Battery

If the LCD monitor displays the Set Date / Time menu when you turn on the camera, this means that the Date battery has run down and the clock has stopped running. Please purchase a replacement battery (battery type CR2016) and install it as follows. (The date battery is preinstalled at the factory and may therefore expire earlier than its rated lifespan after the camera has been purchased.)



- Be particularly careful to keep the date batteries out of the reach of children. Seek medical assistance immediately if a child swallows a battery since corrosive battery fluids could damage the stomach or intestinal wall.

1

Be sure that the camera is turned off.

2

Pull out the date battery holder in the direction of the arrow.

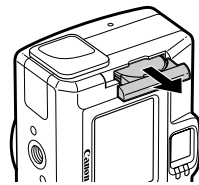

3

Shift the date battery slightly in the direction of the arrow ① and pull out the battery in the direction as shown with arrow ②.

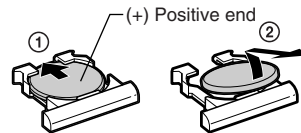

4 Insert the new date battery into the holder with the (+) side facing up.

5 Replace the date battery holder back into its original position.

6 Set the date and time when the Set Date / Time menu is displayed on the LCD monitor (p. 24).



- The LCD monitor also displays the Set Date / Time menu the very first time you turn on the camera. This is normal, and you don't need to replace the date battery.

- If you should dispose of your camera, first remove the date battery for recycling according to the recycling system of your country.



Using the Optional Battery Kits

Using Rechargeable Batteries

(Battery and Charger Kit CBK100)

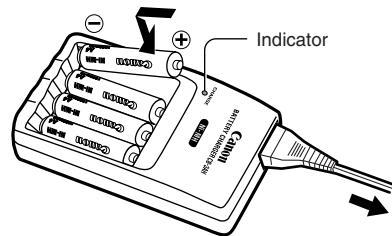

* Two batteries can be charged instead of four.



- Four batteries are supplied with the Battery and Charger Kit CBK100, however, only two batteries are used for this camera.
- The indicator flashes while charging, then comes on solid when charging is finished.



- This charger can be used only to charge Canon AA-size NiMH batteries. Please do not attempt to charge any other type of batteries with this charger.
- Never mix unused batteries together with batteries that have been used in other devices.
- When recharging batteries from the camera, always recharge both of them at the same time.
- Do not mix batteries with different purchase dates or different charge states.
- Do not attempt to recharge fully charged batteries, as doing so may reduce or impair battery performance.
- Do not recharge batteries in enclosed areas that tend to retain heat.
- Repeatedly recharging batteries before they become fully depleted may cause batteries to lose capacity. Do not recharge the batteries until the LCD monitor displays the "Change the batteries" message.
- Wipe the battery terminals well with a dry cloth in the following situations, as the terminals may be soiled with oil from one's skin or other dirt:
 - If the battery usage time has considerably diminished

- If the number of recordable images has considerably diminished
- When charging the batteries (insert and remove the batteries two or three times before charging)
- When charging completes in a matter of a few minutes (the battery charger indicator remains lit)
- Always keep the ⊕ and ⊖ terminals of batteries, battery charger and camera clean. Dirt may cause a bad electrical contact. Wipe them well with a dry cloth before recharging or using them.
- You may not be able to fully charge the batteries due to their specifications right after purchase or after long periods of non-use. If this happens, use the batteries until their charge is depleted before charging them again. After doing this several times, battery performance will be restored.
- If battery usage time is considerably low despite their terminals' being wiped and the battery charger's indicator remaining lit, it is possible that the batteries have reached the end of their lifespan. Switch to different, unused batteries. If you are purchasing new batteries, look for Canon's AA-size NiMH batteries.

- Leaving batteries in the camera or charger may damage it causing battery leakage. Remove batteries from the camera or charger and store in a dry cool location when not in use.



- It takes approximately 110 minutes (for two) and 220 minutes (for four) for the charger to fully recharge the batteries (as determined by testing at Canon facilities). Please do not charge batteries in areas where the temperature is outside the range of 0 to 35 °C (32 to 104 °F).
- Charging time varies according to ambient temperature and to the batteries' initial charge state.

Using the Household Power Source (AC Adapter Kit ACK800)

Use of the ACK800 optional AC adapter kit is recommended when using the camera continuously for prolonged periods of time and when connecting to a computer.



- Be sure that the camera is turned off before connecting or disconnecting the compact power adapter.

- 1 Connect the power cable to the compact power adapter, and then plug the other end into the electrical outlet.

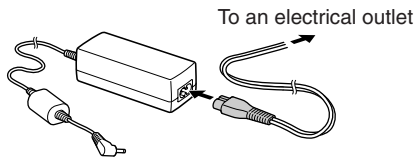

2

Open the Terminal cover, and connect the adapter's DC plug into the camera's DC IN terminal.

- Please unplug the adapter from the power outlet when you have finished using the camera.

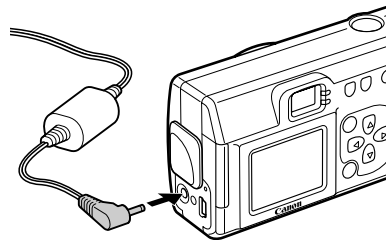

- Please do not attempt to use any AC adapter other than AC Adapter Kit ACK800 with your camera. Use of a different adapter may result in damage to the camera or to the adapter kit.

Camera Care and Maintenance

Clean the camera by using the following methods when the camera, lens, viewfinder, LCD monitor or other surfaces become dirty.

Camera Body:	Wipe the camera body with a soft cloth or eyeglass lens wiper.
Lens:	Clean dust and dirt off the lens with a commercially available lens blower brush, then wipe lightly with a soft cloth. <ul style="list-style-type: none"> • Never wipe the camera or lens with cleaners that contain organic solvents. If you are unable to remove the dirt from the lens, contact the Canon Customer Support Help Desk.
Viewfinder:	Clean with a lens blower brush. If necessary, wipe lightly with a soft cloth or eyeglass lens wiper.
LCD Monitor:	Clean with a lens blower brush. If necessary, wipe lightly with a soft cloth or eyeglass lens wiper. <ul style="list-style-type: none"> • Don't press strongly on the monitor or rub it forcefully. Strong pressure or rubbing may cause scratches on the surface.



- Never use water, paint thinner, benzene, or detergents to clean the camera, as these may cause damage or deformation.

Troubleshooting

Problem	Cause	Solution
The camera doesn't function.	The camera is turned off.	• Turn the power on. (See "Turning the Power ON / OFF" (p. 27).)
	The CF card slot / battery cover is open.	• Be sure the cover is closed securely.
	Batteries are loaded in the wrong direction.	• Reload the batteries in the correct direction.
	Batteries are depleted.	• Replace with unused alkaline or fully recharged batteries (two AA-size batteries). • Use a household power source.
	Batteries are not the right type.	• Use only unused AA-size alkaline batteries or Canon AA-size NiMH batteries. (For the information about alkaline batteries, see "Proper Battery Handling" (p. 21).)
	Batteries are not making good electrical contact with the camera.	• Wipe the battery terminals with a clean dry cloth.

Problem	Cause	Solution
The camera doesn't shoot.	Camera is in replaying mode.	• Change to the Shooting mode. (See "Switching Between Shooting / Replay" (p. 28).)
	The flash is charging.	• Wait until the flash charges. You can press the shutter button when the indicator glows a steady orange.
	The CF card is full.	• Insert a new CF card. • Download images to your computer, then erase them from the card to free up more space.
	The CF card is not formatted correctly.	• Format the CF card. (p. 66). • The card may be defective (its logical format may be corrupted). Contact Canon Customer Help Desk.
The batteries are consumed quickly.	Batteries are not the right type.	• Use only unused AA-size alkaline batteries or Canon AA-size NiMH batteries. (For the information about alkaline batteries, see "Proper Battery Handling" (p. 21).)

Problem	Cause	Solution
The batteries are consumed quickly.	Battery capacity drops due to low ambient temperatures.	• If shooting in a cold area, keep the batteries warm (by placing them in an inner pocket, etc.) until ready to use them.
	Battery terminals are dirty.	• Wipe them well with a dry cloth before use.
	The batteries have not been used for over a year.	• If batteries are rechargeable: Performance should return to normal after several charging cycles.
	If using rechargeable batteries: The batteries have lost their effectiveness.	• Replace both batteries with new ones.
If using rechargeable batteries: Batteries do not charge.	Batteries were placed in the charger in the wrong direction.	• Put batteries back into the charger in the correct direction.
	Poor electrical contact, between batteries and the charger.	• Wipe the battery terminals with a dry, clean cloth. • Be sure to set batteries firmly into the charger. • Be sure that the power cable is firmly connected to the charger, and is firmly plugged in to the electrical outlet.
	Battery terminals are dirty.	• Wipe them well with a dry cloth before charging.
	The batteries have lost their effectiveness.	• Replace both batteries with new ones.

Problem	Cause	Solution
Shots are blurry or unfocused.	The camera was moving when you took the shot.	• Hold the camera steady when shooting.
	Autofocus function hampered by obstruction to AF-assist beam.	• Be careful not to block the AF-assist beam flash part with a finger or other object.
	The AF-assist beam settings are set to [Off].	• Turn the [AF-assist beam] of the Rec. menu [On] (p. 88).
	The subject was outside the range over which the camera can focus.	• Ensure that there is at least 20 cm (7.9 in.) between the camera lens and subject. • Use the macro mode to shoot close-ups between 5 to 20 cm (2 to 7.9 in.) from the lens. • When shooting distant subjects, set the camera to infinity mode.
The subject comes out underexposed (too dark).	Insufficient light for shooting.	• Set the flash on.
	The subject is darker than the surroundings.	• Set exposure compensation to a positive value.

Problem	Cause	Solution
The subject comes out underexposed (too dark).	The subject is beyond the range of the flash.	• When flash is used, the distance between lens and subject should not exceed 2 m (6.6 ft.).
The subject comes out overexposed (too bright).	The subject is too close to the flash.	• When flash is used, the distance between lens and subject should be no less than 20 cm (7.9 in.).
	The subject is brighter than the surroundings.	• Set exposure compensation to a negative value.
	Light is shining or reflecting into the camera.	• Adjust the camera angle.
	The flash mode is set to On.	• Set the flash to any other mode except On.
The flash doesn't fire.	The flash mode is set to Off.	• Set the flash to any other mode except Off.

Specifications

All data is based on Canon's standard testing methods.
Subject to change without notice.

● Specifications ●

	PowerShot A200	PowerShot A100
Camera Effective Pixels	Approx. 2 million	Approx. 1.2 million
Image Sensor	1 / 3.2 in. CCD (Total number of pixels: approx. 2.1 million)	1 / 3.2 in. CCD (Total number of pixels: approx. 1.3 million)
Lens	5 mm (35 mm film equivalent: 39 mm), F2.8	
Digital Zoom	Maximum 4 X	Maximum 3.2 X
Optical Viewfinder	Inverted Galilean finder	
LCD Monitor	1.5 inch low-temperature polycrystalline silicon TFT color LCD, approx. 120,000 pixels	
Autofocus	TTL 3-point AiAF / TTL 1 point center AF, Focus lock possible	
Focusing Range	Normal: 20 cm (7.9 in.) - ∞, Macro AF: 5 - 20 cm (2 - 7.9 in.)	
Shutter	Mechanical + electronic	
Shutter Speed	1 - 1 / 2000 sec. • 1 - 1 / 6 sec. in manual mode with the flash off or in slow synchro mode. • Noise reduction processing on speeds between 1 - 1 / 6 sec.	
Light Metering Method	Evaluative metering (linked to focusing point)	
Exposure Control	Program AE	

	PowerShot A200	PowerShot A100
Exposure Compensation	± 2 EV (in 1 / 3 - step increments)	
Sensitivity	ISO 50 / 100 / 200 / 400 equivalent and Auto (In Auto mode, camera automatically adjusts sensitivity in the range of ISO 50 to ISO 150 equivalent)	ISO 64 / 100 / 200 / 400 equivalent and Auto (In Auto mode, camera automatically adjusts sensitivity in the range of ISO 64 to ISO 150 equivalent)
White Balance	TTL auto / preset (daylight, cloudy, tungsten, fluorescent, fluorescent H)	
Flash	Red-eye reduction auto / auto / on / off / slow-synchro	
Flash Range	20 cm - 2m (7.9 in. - 6.6 ft.) (When sensitivity is set to AUTO)	
Shooting Modes	Auto / manual / stitch assist / movie	
Continuous Shooting	Approx. 2 images / sec. (Large / fine mode, LCD monitor off)	Approx. 3 images / sec. (Large / fine mode, LCD monitor off)
Self-Timer	Shoots after approx. 10 sec.	
PC Connected Shooting	Available (USB connection only. Exclusive software program "RemoteCapture" is included in the camera kit.)	
Recording Media	CompactFlash™ card (Type I)	
File Format	Design rule for Camera File System, DPOF compliant	
Image Recording Format	Still images : JPEG (Exif 2.2)*, Movies : Motion JPEG	
Compression	Superfine / fine / normal	

		PowerShot A200	PowerShot A100
Number of Recording Pixels	Still Images	Large : 1600 × 1200 pixels Medium : 1024 × 768 pixels Small : 640 × 480 pixels	Large : 1280 × 960 pixels Medium : 1024 × 768 pixels Small : 640 × 480 pixels
	Movies	320 × 240 pixels (Approx. 9 sec.) 160 × 120 pixels (Approx. 26 sec.) Approx. 20 frames / sec. The data in parentheses refer to the maximum movie length per shooting	320 × 240 pixels (Approx. 14 sec.) 160 × 120 pixels (Approx. 30 sec.) Approx. 15 frames / sec. The data in parentheses refer to the maximum movie length per shooting
Replay Modes	Single image replay / index replay (9 thumbnails) / zoomed view (LCD monitor zooms images up to maximum of approx. 10) / auto play / printing with Card Photo Printer CP-100 or CP-10 (Direct Print function)		
Language	English / Deutsch / Français / Nederlands / Dansk / Suomi / Italiano / Norsk / Svenska / Español / Chinese or Japanese (depending on the region)		
Interface	Universal Serial Bus (USB) (mini-B)		
Power Source	Two AA-size alkaline batteries (included), Two AA rechargeable NiMH batteries (optional), Compact Power Adapter CA-PS800 (optional)		
Operating Temperatures	0 – 40°C (32 – 104°F)		
Operating Humidity	10 – 90%		
Dimensions (w × h × d)	110 × 58 × 36.6 mm (4.3 × 2.3 × 1.4 in.) (excluding protrusions)		
Weight	Approx. 175 g (6.2 oz.) (excluding batteries and CF Card)		

* This digital camera supports Exif 2.2 (also called "Exif Print"). Exif Print is a standard for enhancing the communication between digital cameras and printers. By connecting to an Exif Print-compliant printer, the camera's image data at the time of shooting is used and optimized, yielding extremely high quality prints.

Battery Performance

	Number of Shots		Replay Time
	LCD Monitor ON	LCD Monitor OFF	
AA Alkaline Batteries (included with the camera)	A200: Approx. 90 shots A100: Approx. 100 shots	A200: Approx. 300 shots A100: Approx. 380 shots	Approx. 90 min.
AA NiMH Battery NB-1AH	A200: Approx. 200 shots A100: Approx. 210 shots	A200: Approx. 550 shots A100: Approx. 630 shots	Approx. 120 min.

















<Test Conditions>

Shooting : Room temperature (23°C, 73°F), alternating the shots every 20 seconds, flash used once every four shots, power turned off and on again after every 8 shots.

Replay : Room temperature (23°C, 73°F), continuous replay at 3 seconds per image.

• For information on handling batteries, see "Proper Battery Handling" (p. 21).

CF Cards and Estimated Capacities (Recordable Images)

		FC-8M	FC-16M	FC-32M	FC-64M	FC-128M
L (1600 x 1200 pixels) PowerShot A200		7	15	31	64	128
		11	24	49	100	200
		24	48	99	200	401
L (1280 x 960 pixels) PowerShot A100		10	21	43	88	177
		16	32	67	135	271
		32	64	131	263	528
M (1024 x 768 pixels)		16	32	67	135	271
		24	49	102	205	412
		46	92	189	379	760
S (640 x 480 pixels)		35	70	143	288	577
		50	99	206	415	831
		87	172	353	707	1417
Movie PowerShot A200	 (320 x 240 pixels)	18 sec.	36 sec.	76 sec.	152 sec.	305 sec.
	 (160 x 120 pixels)	48 sec.	97 sec.	198 sec.	399 sec.	799 sec.
Movie PowerShot A100	 (320 x 240 pixels)	24 sec.	49 sec.	100 sec.	201 sec.	404 sec.
	 (160 x 120 pixels)	63 sec.	126 sec.	263 sec.	527 sec.	1056 sec.



* The shooting time for 1 movie





 PowerShot A200: approx. 9 seconds, PowerShot A100: approx. 14 seconds

 PowerShot A200: approx. 26 seconds, PowerShot A100: approx. 30 seconds

The figures in the table reflect recording times for repeated shooting.

Approximate File Size for One Image

	L (1600 x 1200 pixels) PowerShot A200	L (1280 x 960 pixels) PowerShot A100	M (1024 x 768 pixels)	S (640 x 480 pixels)
 Superfine	957 KB	693 KB	450 KB	208 KB
 Fine	611 KB	450 KB	294 KB	141 KB
 Normal	302 KB	228 KB	155 KB	79 KB

- **L** (Large), **M** (Medium), **S** (Small), ,  : expresses the resolution.
- , ,  : expresses compression.

NiMH Battery NB-1AH

Supplied with the optional NiMH Battery NB4-100 set and the Battery / Charger Kit CBK100.

Type	Rechargeable nickel hydride battery
Nominal Voltage	1.2 V DC
Typical Capacity	1600 mAh (min.:1550 mAh)
Cycle Life	Approx. 300 times
Operating Temperature	0 - 35 °C (32 - 95 °F)
Dimensions	Diameter: 14.5 mm (0.6 in.) Length: 50 mm (2 in.)
Weight	Approx. 27 g (0.95 oz.)

Battery Charger CB-3AH

Supplied with the optional Battery and Charger Kit CBK100.

Rated Input	100 - 240 V AC (50 / 60 Hz), 8W
Rated Output	1.6 V DC / 2 A
Charging Time	Approx. 110 minutes for two batteries, 220 minutes for four batteries
Operating Temperature	0 - 35 °C (32 - 95 °F)
Dimensions	113 × 74 × 27.5 mm (4.4 × 2.9 × 1.1 in.)
Weight	Approx. 100 g (3.5 oz.) (body)

Compact Power Adapter CA-PS800

Supplied with the optional AC Adapter Kit ACK800.

Rated Input	100 - 240 V AC (50 / 60 Hz), 16VA (100V) - 26VA (240V)
Rated Output	3.15 V DC / 2 A
Operating Temperature	0 - 40 °C (32 - 104 °F)
Dimensions	42.5 × 104.4 × 31.4 mm (1.7 × 4.1 × 1.3 in.)
Weight (body)	Approx. 180 g (6.4 oz.)

CompactFlash™ Card

Card Slot Type	Type 1
Dimensions	36.4 × 42.8 × 3.3 mm (1.4 × 1.7 × 0.1 in.)
Weight	Approx. 10 g (0.4 oz.)

Index

A

Adjusting the Exposure	52
AF-assist Beam	4, 34
AiAF	51
Autofocus	33, 51

B

Batteries	
Battery Performance	109
Battery Status Indications	23
Installing	19
Proper Battery Handling	21

C

Camera Care and Maintenance	100
CF Cards	
About CF Cards	23
CF Card Slot/Battery Cover	5
CF Cards and Estimated Capacities ...	110
Formatting	66
Installing	19
Compression	41

Continuous Mode	46
-----------------------	----

D

Date	24
Default Settings	38, 91
Digital Zoom	35
Downloading Images to a Computer	
Connecting the Camera to a Computer	
Via the USB Cable	85
Downloading Directly from a CF Card ...	84
Using a PC card reader	84
DPOF	76, 82

E

Erasing	
Erasing All Images	65
Erasing Images Individually	65

F

File Number	56
File Size	111
Flash	43
Focus Lock	50

Functions	57
I	
Image Transfer Settings (DPOF Transfer Order)	82
Index View	60
Indicators	6
Infinity	45
ISO Speed	55
L	
Language	25
LCD Monitor	
Information Displayed	31
Using	29
M	
Macro	45
Magnifying Images	59
Menus	36
Movie	
Recording	49
Replay	61

P

Photo Effect	54
Play Menu	89
Power Save Function	27
Pressing Fully	34
Pressing Halfway	34
Printing	
About Printing	67
Connecting the Camera to a Printer	69
DPOF Print Settings	76
Print Order Menu	68
Print Settings (Direct Print Function) ...	72
Print Style	72, 78
Printing	71
Printing with DPOF Print Settings	80
Resetting the Print Settings	79
Selecting Images for Printing	76
Protecting	64

R

Red-Eye Reduction	43, 44
Replacing the Date Battery	95

Replaying	
Auto Play	63
Displaying Images Individually	59
Rotating Images in the Display	62
Viewing Images in Sets of 9	60
Resolution	41

S

Self-Timer	46
Set up Menu	90
Setting	
AF-assist Beam	88
AiAF	88
Auto Power Down	90
Beep	90
Date/Time	90
Digital Zoom	88
File No. Reset	88
Format	90
Resetting the Settings to Default	91
Review	88
Shooting	40

Shutter Button	34
Single Image Replay	59
Stitch Assist	47
Strap Eyelet	5

T

Terminal Cover	4, 85
Time	24
Turning the Power ON	27

U

Using the Optional Battery Kits	
Using Rechargeable Batteries	96
Using the Household Power Source ...	99

V

Viewfinder	33
------------------	----

W

White Balance	53
---------------------	----

Disclaimer

- While every effort has been made to ensure that the information contained in this guide is accurate and complete, no liability can be accepted for any errors or omissions. Canon reserves the right to change the specifications of the hardware and software described herein at any time without prior notice.
- No part of this guide may be reproduced, transmitted, transcribed, stored in a retrieval system, or translated into any language in any form, by any means, without the prior written permission of Canon.
- Canon makes no warranties for damages resulting from corrupted or lost data due to a mistaken operation or malfunction of the camera, the software, the CompactFlash™ cards (CF cards), personal computers, peripheral devices, or use of non-Canon CF cards.

Trademark Acknowledgments

- Canon and PowerShot are trademarks of Canon, Inc.
- CompactFlash is trademark of SanDisk Corporation.
- iBook and iMac are trademarks of Apple Computer, Inc.
- Macintosh, PowerBook, Power Macintosh and QuickTime are trademarks of Apple Computer, Inc, registered in the United States and other countries.
- Microsoft, Windows, and Windows NT are either registered trademarks or trademarks of Microsoft Corporation in the United States and / or other countries.
- Other names and products not mentioned above may be registered trademarks or trademarks of their respective companies.

FCC Notice

(Digital Camera, Model PC1021 and PC1025)

This device complies with Part 15 of the FCC Rules. Operation is subject to the following two conditions;

(1) this device may not cause harmful interference, and

(2) this device must accept any interference received, including interference that may cause undesired operation.

Note: This equipment has been tested and found to comply with the limits for Class B digital devices, pursuant to Part 15 of the FCC rules. These limits are designed to provide reasonable protection against harmful interference in a residential installation.

This equipment generates, uses and can radiate radio frequency energy and, if not installed and used in accordance with the instructions, may cause harmful interference to radio communications. However, there is no guarantee that interference will not occur in a particular installation. If this equipment does cause harmful interference to radio or television reception, which can be determined by turning the equipment off and on, the user is encouraged to try to correct the interference by one or more of the following measures:

- Reorient or relocate the receiving antenna.
- Increase the separation between the equipment and receiver.
- Connect the equipment into an outlet on a circuit different from that to which the receiver is connected.
- Consult the dealer or an experienced radio / TV technician for help.

The cables with the ferrite core provided with the digital camera must be used with this equipment in order to comply with Class B limits in Subject B of Part 15 on the FCC rules.

Do not make any changes or modifications to the equipment unless otherwise specified in the manual. If such changes or modifications should be made, you could be required to stop operation of the equipment.

Canon U.S.A. Inc.

One Canon Plaza, Lake Success, NY 11042, U.S.A.

Tel No. (516) 328-5600

Canadian Radio Interference Regulations

THIS CLASS B DIGITAL APPARATUS MEETS ALL REQUIREMENTS OF THE CANADIAN INTERFERENCE CAUSING EQUIPMENT REGULATIONS.

Réglementation canadienne sur les interférences radio

CET APPAREIL NUMERIQUE DE LA CLASSE B RESPECTE TOUTES LES EXIGENCES DU REGLEMENT SUR LE MATERIEL BROUILLEUR DU CANADA.